

Steam sterilizer

MANUAL



Please appoint special person to operate and maintain the device. The operator and maintenance must be well trained

Catalogue

Catalogue.....	3
Using Range of this instruction:	4
Device's Record:	5
Explanation of symbols	6
Safety cautions:	7
1. General Introduction.....	8
2. Using Range	8
3. Parameters and process of the sterilizer	8
4. Control Panel.....	9
5. Installation	15
6. Operation	16
7. Abnormal Situations.....	18
8. Maintenance	19
9. Transport and Storage.....	23
10. Guarantee.....	23
11. Accessories	23
Appendixes	24
Appendix2: Circuit diagram.....	26
Appendix3: EMC.....	27

Using Range of this instruction :

This instruction covers the models of pressure steam sterilizer as below :

YS-12L-E、YS-18L-E、YS-22L-E



Do not used in a manner not specified by the manufacture.

Device's Record :

Item: _____ Steam Sterilizer _____

Model: _____

SN.: _____

Attentions :

- Read this instruction carefully before start to use Pressure Steam Sterilizer
- Following the instruction seriously when you use Pressure Steam Sterilizer
- Please keep this instruction for reference in the future
- Contact with sellers or manufacturer if the Pressure Steam Sterilizer has any problems.
- Please appoint special person to operate and maintain the device. The operator and maintenance must be well trained

Explanation of symbols on unit



Caution, Read the instruction for use



Symbol for “PROTECTIVE CONDUCTOR TERMINAL”



Symbol for “HOT SURFACE”



Symbol for “ENVIRONMENT PROTECTION – Waste electrical products should not be disposed of with household waste. Please recycle where facilities exist. Check with your local Authority or retailer for recycling advice”.



Symbol for “MANUFACTURER”

CE 0197 Symbol for “COMPILES WITH MDD93/42/EEC REQUIREMENTS”



Symbol for “DATE OF MANUFACTURE”



Symbol for “SERIAL NUMBER”



Symbol for “EUROPEAN REPRESENTATION”



Symbol for “THIS WAY UP”



Symbol for “KEEP AWAY FROM RAIN”



Symbol for “DO NOT ROLL”



Symbol for “STACKING LIMITED 3”



Symbol for temperature limits are 5°C~40°C



≤80%

Symbol for The relative humid: ≤80%

Safety cautions :

Please read it carefully.



If you ignore these “cautions”, may cause electric shock, fire or equipment damages.

- 1、 **Please use three holes socket (230±23VAC/10A/50Hz~60Hz),and be sure the socket is connected to the ground.**
Do not put the device on the place where is very difficult to cut off the power.
- 2、 **Please don't use any other voltage powers.**
- 3、 **Never touch the plug or the socket by wet hands.**
- 4、 **Don't pull, change, over-bend or twist wire, or don't leave heavy things on wire.**
- 5、 **Don't put the sterilizer on an unstable shelf or caunter or surfaces which could cause a fire or fume.**
- 6、 **Don't block the sterilizer's ventilation and radiation.**
- 7、 **Don't put anything on the sterilizer.**
- 8、 **If the user smells or hears abnormally during running (it doesn't include the noise of pumps), then cut off the power and contact sellers or manufacturer.**
- 9、 **Please cut off the power if the user won't use the sterilizer for a long time.**

1. General Introduction

YS Steam Sterilizer is operated by doctors or professionals and is designed specially for clinic, hospital, laboratory etc. The sterilizer uses microprocessor with intelligence control system, and humanistic interface, operate easily, safety and reliable. The parameters and conditions of the sterilizer will be displayed on the digital screen during the processing. For ensuring the reliability of sterilization, the machine will do trouble self-diagnose and self-protect automatically during overheat or overpressure situations. Inside of the sterilizer has a collector of condensate water that prevents the steam from polluting the environment.

2. Using Range

This sterilizer is for sterilization of invasive medical devices. It can prevent cross infection.

This sterilizer is highly penetrability for department of hospital, stomatology, ophthalmology, and biological research institute. Sterilizing surgical equipments, stomatology instruments and syringes etc. It can sterilize the wrapped or non-wrapped, solid, hollow load products type A and porous products as represented by the test loads in the standard “EN13060:2004+A2:2010”.

This sterilizer is also can use in non-medical and veterinary applications.



Do not sterilize liquid!

3. Parameters and process of the sterilizer

3.1 Parameters:

The condition of using the sterilizer:

Temperature of environment: 5°C ~ 40°C;

Relative humidity: ≤80%;

Bactericidal pressure: >70kPa;

Input: 230VAC, 50Hz, 2500VA

The condition of working:

The highest rated working pressure: 0.21 ~ 0.23MPa;

The highest rated working temperature: 134 ~ 137°C;

Life time: 5 years

The condition of transport and storage:

The temperature range: 5 ~ 40°C

The relative humid: ≤80%

No corroding gases

The measure of device: see below picture.

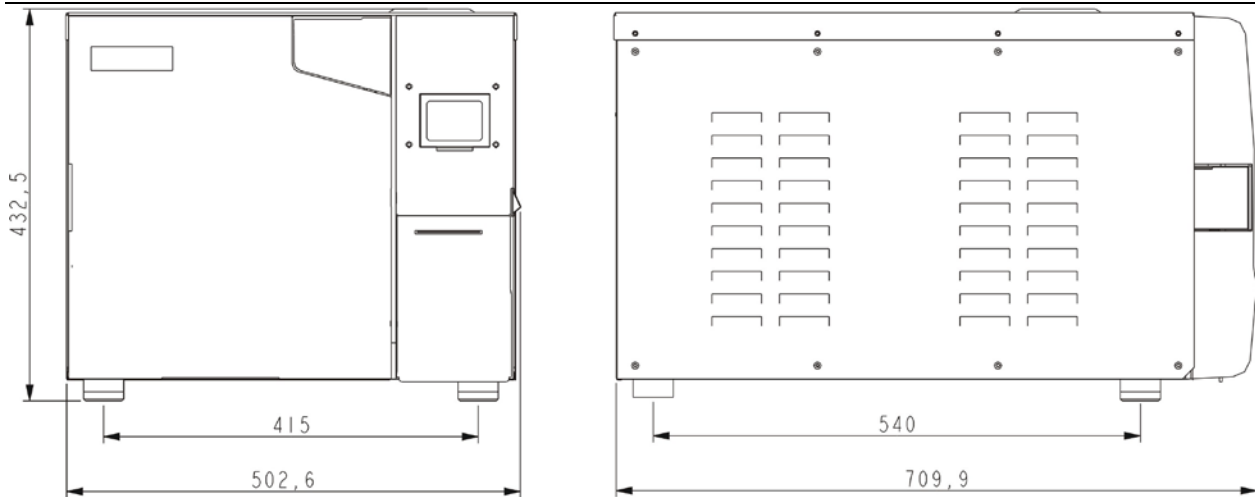

The net weight of the device:

YS-12L-E: 47.7Kg

YS-18L-E: 50.25KG

YS-22L-E: 53.5KG

3.2 Parameters of the sterilizer

Process	Vacuum times	sterilizing time	Sterilizing temperature	Sterilizing pressure	Vacuum persist time	Dry time
121°C/SOLID	1 *	20min *	121°C	110kPa	/	3 *
121°C/POROUS	3 *	20min *	121°C	110kPa	/	7 *
121°C/HOLLOW	3 *	20min *	121°C	110kPa	/	10 *
134°C/SOLID	1 *	4min *	134°C	210kPa	/	3 *
134°C/POROUS	3 *	4min *	134°C	210kPa	/	7 *
134°C/HOLLOW	3 *	4min *	134°C	210kPa	/	10 *
USER DEFINED	3 *	5min *	134°C*	210kPa	/	10 *
B-D TEST	3	4min	134°C	210kPa	/	7
VACUUM TEST	/	/	/	-80kPa	15min	/
CLEAN PROCESS	3	5min	105°C	20kPa	/	10
PRIONEN	3	19min	135°C	210kPa	/	10

The data have “*” can be adjusted



B-D Test: Countdown on the display shows 4min, but normally it takes 3.5min.

4. Control Panel

4.1. LCD screen presentation

4.1.1 ■P/ON: Indicate the status of printer

The relative menu :

“ADV → PRINTER:ON/OFF” .



LCD screen

Quick bar

Button

ON indicate that: the printer can work.

OFF indicate that: the printer can't work

User can change the printer's status in menu:

“ADV → PRINTER:ON/OFF ”

4.1.2 ■K/OFF: Indicate the status of function of “Keep temperature”

The relative menu:

“ADV → KEEP TEMP:ON/OFF” .

ON indicate that the sterilizer will heat the chamber and steam generator to preset temperature, when the door is opened, the sterilizer will stop heating the chamber and steam generator. The longest time to keep temperature is 8 hours.

Setting it on can shorten the time of the whole cycle.

User can change the option of keep temperature in menu: “ADV → KEEP TEMP:ON/OFF”

4.1.3 ■W/OFF: Indicate the status of function of “Preheat”

The relative menu: “ADV → PREHEAT:ON/OFF” .

ON indicate that if user run a sterilizer program,the sterilizer can't execute the next step until the temperature in chamber reach 50℃ .

User can change the option of preheat in menu: “ADV → PREHEAT:ON/OFF”



set ■W/ON, The sterilizer will take very long time to finish the whole cycle.

The standards of some states require this function, please Check with your local standards and set it.

4.1.4 COUNT: Times of already running sterilization program

00023 indicate the sterilizer have ran 23 times

B&D/helix test and vacuum test are not counted.

4.1.5 2 Kpa:

It indicates that the pressure in the chamber is 2 Kpa;

when the sterilizer's door is opened, this pressure is the local air pressure.

4.1.6 14:09:00: Time

User can set it in menu: “ADV → DATE/TIME”

4.1.7 26-11-2011: Date

User can set it in menu: “ADV → DATE/TIME”

4.1.8 USER: User menu

All programs are in this menu, User can select the program in this menu.

4.1.9 ADV: Advance menu/Set menu

User can change options and set the Parameters in this menu

4.1.10 SERV: Serve menu

This menu is for maintenance , only the personnel can enter it with password, user can not enter it

4.1.11 134℃/solid : Shortcut area,

There can record the program which was implemented last time. Users need not to enter

USER menu to select the same program.

4.2、 Menu “USER” presentation

Eleven process for user to select:



121°C-program and 134°C-program has no difference in sterilization , please take 121°C program for the instruments temperature resistance below 134°C

Solid program can only sterilize solid instruments without wrapped, such as plier, forfex, forceps etc.

Porous program can sterilize the loads which made of porous material

Hollow program can sterilize the hollow A and houllow B loads

User-defined program, All this program’s parameters can be adjusted: The sterilization temperature、 the sterilization time、 dry time and vacuum times.

B-D test is for hollow A loads test . B-D test and Helix test is the same test program. The only difference is that B-D test uses a B-D test package, while Helix test uses a Helix test device (PCD:process challenge device).

Vacuum test is air leakage test.



we suggest that user do a vacuum test every mouth. If the result is FAIL, Do not use this device.

Clean program. This program is used to clean the pipeline of the equipment. When the sterilizer displays the prompt of “NEED CLEAN”, it shall run this program to clear this display.

Prion program. This program is to sterilize prion virus. For example: Mad cow virus.

4.3、 ADV MENU

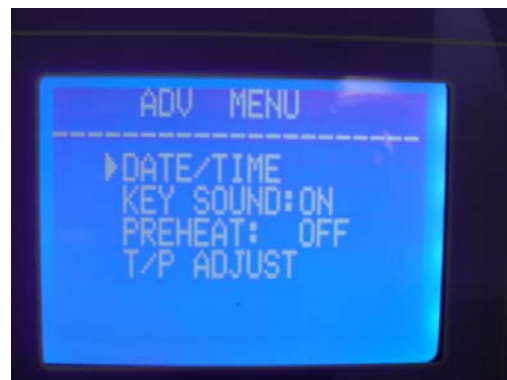

▶ : Cursor

User can press button “up” or “down” to move cursor.

When the cursor is before the option which user want to set , user can press “OK” to change the setting.

4.3.1、KEEP TEMP

The relative parameter is “■K” in first page.

ON: The sterilizer will heat the chamber and steam generator to preset temperature, when the door is opened, the sterilizer will stop heating the chamber and steam generator. The longest time to keep temperature is 8 hours. Setting it on can shorten the time of the whole cycle.

OFF: The sterilizer will not heat the chamber and steam generator.

4.3.2、PRINTER

ON: The printer will print the records during the working cycle.

OFF: The printer will not print the records during the working cycle.

4.3.3、LANGUAGE

ENG: English

ITL: Italian

4.3.4、USER-DEFINED SET

Setting of program “USER-DEFINED” , When the cursor is before this option, user can enter detailed setting page by pressing “OK”. The detailed setting page:



When the cursor is before this option, User can press “UP” or “DOWN” to change the setting.

Press “OK” the cursor moving to next option.

VACUUM TIMES:

Setting of vacuum times during the sterilization cycle,

04: Meaning that: the program “USER-DEFINED” have 4 times vacuum process.

The range of the “VACUUM TIMES” is 1~10.

STER TEMP:

Setting of sterilization temperature,

134°C: The sterilizer temperature of program “USER-DEFINED” is 134 °C

The range of the “STER TEMP” is 105°C~134°C.

STER TIME:

Setting of sterilization time,

05Min: . The sterilizer time of program “USER-DEFINED” is 05Min

The range of the “STER TIME” is 04min-60min.

DRY TIME:

Setting of dry time.

10Min: . The dry time of program “USER-DEFINED” is 10Min

The range of the “DRY TIME” is 04min-60min.

OK:

Save setting and return to the page of the upper.

4.3.5、ADJUST STER PAR:

When the cursor is before this option, User can press “OK” to enter the program selection page.

There are six programs can be adjusted(Pic1).



(Pic 1)



(Pic2)

When you select the program which you want to adjust by pressing “UP” or “DOWN”, user press “OK” to enter the next page. For example 134°C SOLID(Pic2)

There can adjust three parameters: STER TIME、VACUUM TIMES and DRY TIME.

The setting method is the same as the setting of user-defined program,

DEFAULT: Return to default.

Move the cursor to the “DEFAULT” option by pressing “OK”, press “UP” to default the parameters.

4.3.6、USER PASSWORD

If user set a user password and set the “ENABLED” to “ON”, user power on the sterilizer, user must input correct password first, if the password is not correct, user can't use the sterilizer.

If user forget the password, please contact the seller or manufacturer.

When the cursor is before the “USER PASSWORD” option in “ADV” menu, press “OK” to enter the next page(pic 3).

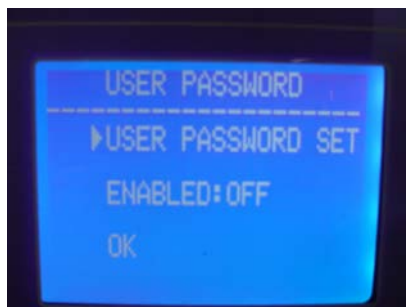

(Pic3)

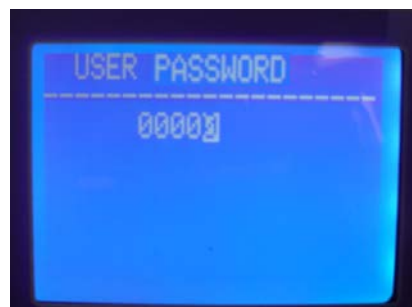

(Pic 4)

USER PASSWORD SET:

When the cursor is before the “USER PASSWORD SET” option, then press “OK” to enter the next page (pic 4)

User can change the “0” with white fill by press “UP” or “DOWN”,

UP: +1;

DOWN:-1

Press “START” to change the place of the digit which you want to change.

ENABLED:

ON: the password which you set work.

OFF: the password which you set can't work.

OK: Return to the page of the upper.

4.3.7 DATE/TIME

When the cursor is before the “DATE/TIME” option,

Press “OK” to enter the next page.

Press “UP” or “DOWN” to change the date:

UP: +1;

DOWN:-1

Press “START/STOP” to change the place of the digit which user want to change.

4.3.8 KEY SOUND

When the cursor is before the “KEY SOUND” option, press “OK” to change “ON” or “OFF”.

ON: Press a key with a sound.

OFF: Press a key without a sound

4.3.9 PREHEAT

The relative parameter is “■W” in first page.

When the cursor is before the “PREHEAT” option, press “OK” to change “ON” or “OFF”.

ON: If user run a sterilizer program, the sterilizer can't execute the next step until the temperature in chamber reach 50°C

OFF: If user run a sterilizer program, the sterilizer will execute the next step whenever the temperature in chamber reach 50°C

4.3.10 T/P ADJUST

When the cursor is before the “T/P ADJUST” option, Press “OK” to enter the next page (Pic5).

This menu is to adjust the temperature sensors's base value. If user find the display temperature is lower or higher than actual temperature. User can adjust here.

If find lower, user should subtract; higher should add.

TEMP1: The temperature in the chamber.

TEMP2: The temperature outside of the heating ring.

TEMP3: The temperature of steam generator.



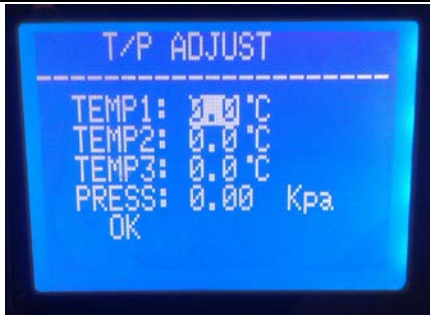

(pic5)

4.4 Press button

4.4.1 UP button

Move up or left

4.4.2 DOWN button

Move down or right

4.4.3 RETURN button

Return to menu of the upper

6.4.4 OK button

Confirm or enter the next menu.

6.4.5 START/STOP button

After the program is selected and confirmed the program, the prompt :“please push the start key to start...”appears, press the button Start/Stop to start the program.

When the program running , press the button Start/Stop to finish the program.

5、 Installation

When user have received the product, open the cover of the box by the screw-driver. Then take the product out by the ropes.



5.1) At least 10 cm space should be left around the sterilizer, and the back space must be at least 20 cm.

Suggest putting sterilizer in well-ventilated location. Don't block the radiator of the sterilizer.

Put the sterilizer on the horizontal shelf or counter.



Make sure the shelf or counter is strong enough to put the device on.

5.2) Adjust atmospheric pressure before the first time use since atmospheric pressure varies from place to place.

Steps:

Cut off the power 2) Open the door 3) Turn on the power, and 20's later, cut off the power, it is done automatically.



If the user don't adjust atmospheric pressure, the sterilizer might not be able to run.

5.3) adjust the date and time.

6. Operation

Preparation before using

Before starting to use the sterilizer, please connect the power, press the main power switch at the right side of the plastic panel in the front, if the indication lamp of this switch is on and LCD screen is also on, That indicates the power of the sterilizer is on. At this time, the program of the sterilizer is in initial status and the sterilizer does not heat. User can select the program which you want to use and start program by pressing the buttons "OK and Start/Stop" successively.



Please ensure to be well grounded.

6.1 Water filling

After opening the power switch of the sterilizer, if LCD screen display the prompt "please fill water" and there is beep, That indicates that the water level in the water tank is too low. As this time the program can't work until fill water full;

Filling water of this series of sterilizers is manual. On the top of the sterilizer, there is a manual water filling hold, as shown in the figure. When the water level in the water tank reaches above the alarm water level, The water shortage prompt will display on LCD. and the beep appears. Fill the water until you hear the voice of "du", it indicates that the water is full.



Please use distilled water to avoid clogging of the steam generator and the valves. Users should be responsible for the consequences it caused.



- 1、 Before top up water, the power must be connected.
- 2、 Please do not put the sterilizer upside down when tank is full.
- 3、 Suggest: Drain the waste storage tank also when the water in the storage water tank used out.

6.2 If you want to use a flash disk to record the data. Please insert the flash disk into usb port.

6.3 Working

When water tank has enough water and waste water tank is not full, it is ready for working.

6.3.1 Put the loads into the chamber



1. No more than 70% of the volume of the sterilizer or no more than 6kg for once.
2. The instruments should not stick to the inside-wall, especially should not block the outlet of the chamber. It should leave at least 10 mm from the inside-wall.
3. Put the test paper into the center of the sterilization package if the user wants to test and judge the sterilization effect.
4. When putting the loads into the sterilizer, we suggest using the tray-hand-holder to prevent from scalded.

6.3.3 Setting

Set the parameters: KEEP TEMP、PRINTER、PREHEAT。

6.3.4 Close door

If the door not be closed correctly, when you have selected the program and press “OK”, the LCD will display “Please close the door”.



If the user feels the handle is too hard to turn, there may be steam still in the sterilizer, we suggest that closing door quickly or waiting for a few seconds to close door.

6.3.5 Choosing program and start

After the door is closed, choose the relative sterilization program according to the loads in the chamber.

All the programs are in “USER” menu. When the cursor moving to “USER” by pressing “UP” or “DOWN”, press “OK” to enter, Move the cursor before the right program by pressing “UP” or “DOWN”, press “OK” to select this program, The LCD will display “please push the start key to start” ,then press “START/STOP” to run this program.

The sterilizer will run pre-heating, 3-times vacuum, sterilization and drying automatically. The time of the whole cycle is decided by the initial temperature, the loads and the program.

When the program is finished, LCD will display “END” with three beeps. The user can open the door and take the sterilized loads out.

6.3.6 When it is not in use, please turn off the power switch (be sure the power lamp is off). If the user won't use the sterilizer for a long time, please disconnect the power.



The user shall fill in water promptly if there is a low-water alert. Otherwise it will show “E08 or E9” error alarm.



1. We strongly suggest using the tray-hand-holder to take the tray out of the sterilizer for preventing scald.
2. Don't open the door until the pressure within "-05~05".



To ensure the effectiveness of sterilization, we suggest putting test paper or pouches with indicators together with the loads into the sterilization chamber every time.

6.3.7 If The LCD display "PLEASE DRAIN WATER FROM WASTER WATER TANK!", this mean the waster water tank is full, you must drain water (See picture in page 22, A is waste water tank bleeder valve) .



The waster water may be hot, be careful to avoid scald.

7.Abnormal Situations

The sterilizer will give alarm, release pressure and stop heating automatically if it has any abnormal situations during working. It will absolutely keep the user safe and display the error code(See the below page 14).

Write down the error code No. and cut off the power, don,t open the door and then turn on the power again to wait the pressure turn back to "-0.5~0.5".



We suggest running one more time to see if the error happens again.

If the user cannot find the resolution from the table, contact with seller or our service department, telling us the error code No., we will help the user to solve it as soon as possible.

Item	Code	Alarm	Reason	Resolution
1	E31	"Du"long beep	Temperature in chamber >150℃;	Check temperature sensor in chamber
2	E32	"Du"long beep	Temperature outside of the heating ring>280℃;	Check temperature sensor outside of the heating ring
3	E51	"Du"long beep	Temperature in chamber $\leq 0^{\circ}\text{C}$;	Check temperature sensor in chamber Check the temperature of the place where the sterilizer put on is below 0°C or not.
4	E52	"Du"long beep	Temperature outside of the heating ring $\leq 0^{\circ}\text{C}$;	Check temperature sensor outside of the heating ring Check the temperature of the place where the sterilizer put on is below 0°C or not.
5	E63	"Du"lo	1、 steam generator temperature $\leq 0^{\circ}\text{C}$; 2、 steam generator temperature>230℃; Steam	Check steam generator temperature sensor, control board,

		ng beep	temperature control instability, over 230°C, steam generator temperature sensor damaged.	steam generator
6	E2	“Du”long beep	The sterilization pressure over preset pressure +0.4bar (134°Cprocess over 3.5bar (absolute pressure) /121°Cprocess over 2.5bar) ; vacuum unusually, have many air remain in chamber.	Check vacuum pump Do a vacuum test
7	E61	“Du”long beep	134°Cprocess : inner temperature >140°C or 121°Cprocess : inner temperature >127°C ; temperature control instability.	Check temperature sensor in chamber.
8	E62	“Du”long beep	Temperature outside of the heating ring>155°C; temperature control instability , control board damaged.	Ask professional check temperature sensor outside of the heating ring, control board, heating ring
9	E41	“Du”long beep	In preheat period, after 8mins temperature outside of the heating ring<100°C; heating circle damaged.	Check heating ring
10	E42	“Du”long beep	In preheat period, after 8mins steam generator temperature <110°C; heating rod damaged.	Check heating rod
11	E5	“Du”long beep	When the period of “sterilization” finished. Drain for 10mins, the pressure in chamber still over 0.5bar; air relief instability.	Check water drain valve
12	E6	“Du”long beep	The door opened in sterilization period; the door detector switch damaged.	Check door detector switch
13	E7	“Du”long beep	The local air pressure value <70KPa;	Can not use in these area Adjust atmospheric pressure:see 5.2 in page 15
14	E8	“Du”long beep	In rise period, every 5mins temperature rise <3°C.	Check water pump, heating rod, control board. Check water tank has enough water.
15	E9	“Du”long beep	In sterilization period, the sterilization pressure below the preset pressure -0.3bar.	Check the water tank has no water.
16	E10	“Du”long beep	The electromagnet in wrong condition (power on, the electromagnet at close condition; process start, the electromagnet at open condition; process finished, the electromagnet at close condition)	check electromagnet, control board
17	E11	“Du”long beep	The electromagnet at open condition during running; the port on control board which use to control electromagnet damaged.	Check control board
18	E12	“Du”long beep	The vacuum not reach -70Kpa 2 times during the program which have 3 times vacuum.	Check vacuum pump
20	E99	“Du”long beep	The communication between CPU is wrong.	Check control board data line, and CPU install

8. Maintenance

The parts must be regular check or replaced:

The germ-tight filter. See 8.5

The seal ring. See 8.7 and 8.8.

The safety valve. See8.9

The operator checking time table:

Item	Operator	Cycle	Maintenance
Door	Professional	2 years	See 8.1
Seal ring	User	1 year	See 8.5
Paper of printer	User	When then printer has no paper	See 8.2
Fuse	Professional	When the fuse is damaged	See 8.6
Safety valve	Professional	1 year	See 8.9

8.1 Door Tightness Adjustment

Door Adjustment:

Push down the lever while turning the door to adjust tightness. As show in below picture, anticlockwise turning will tighten the door, i.e, the door will be closer to the chamber. Therefore, it needs more strength to turn the handle. Clockwise turning the door will loosen it.

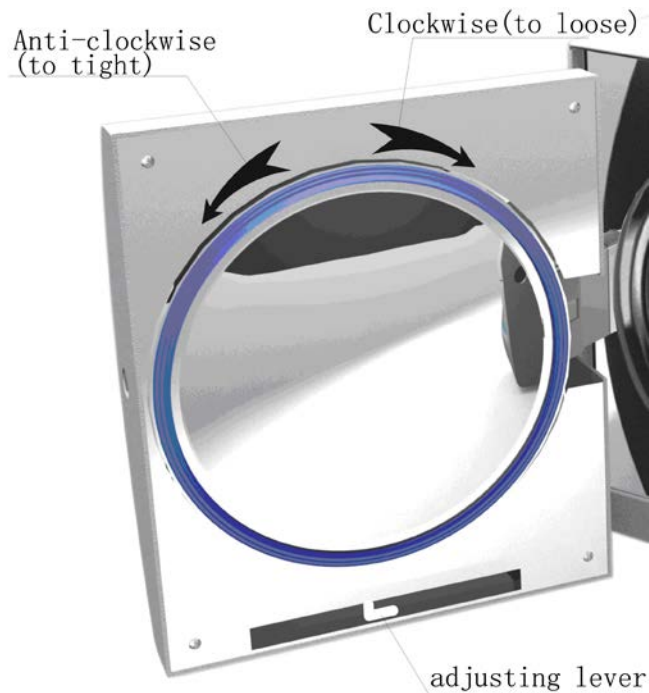

Steps:

- 1) Push down the lever a little
- 2) Turning the door to an angle
- 3) Release the lever
- 4) Keep turning the door to a place where the door cannot move anymore.



After the door adjustment, it needs to do a vacuum test. If there is a leakage, the user shall adjust it again.



If the door is too loose, the sealing ring might be exploded out with a big “bang”. So, please be careful to use this function!

8.2 Change printer paper and paper feed .

Change printer paper:

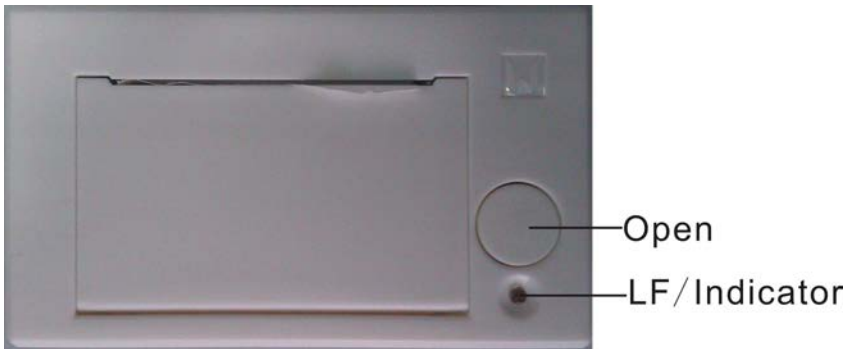

press “open” button of the printer to open the door,
change the paper as the figure 1. cover the door sheet as the figure 2;



(2)

Checking whether the paper change is correct through paper feed.

Printer paper feed check:

when press “LF” button once to see if the paper feed in gear; if the paper feed out of gear, the paper jammed, then change paper and feed again;

If the printer paper feed correct, but where’s no data on the paper, please anti to install the pinter paper.



The printer paper has direction and only one side can be printed on.

8.3. To use disinfectant to clean the tank every week.

8.4 To use ethyl alcohol disinfect and clean the inner surface of the sterilizer every month.

8.5 Every 150 cycles, we recommend to replace the germ-tight filter.

8.6 Replace the fuse

(1) Disconnect power

(2) Push screwdriver and turn the screws in anti-clockwise, and then take the fuse out.

(3) Replace the old fuse by a new one , then turn the screws in clockwise.



Check the parameter of new fuse if it is correct before replacement.

8.7 Clean seal ring regularly

For keeping a good ability of seal, the user should clean the seal ring regularly. Cleaning the seal ring by distilled water. If leaking still happens after clean, the user may have to replace the seal ring.

8.8 Replace the seal ring

Tool: The user needs a screwdriver without sharp.

- A. Hold the seal ring by a hand and use another one to hold a screwdriver carefully to separate the door and the seal ring. Then take the seal ring out slowly.
- B. After the user takes the seal ring out, clean and check it, if it is damaged, the user must replace it.
- C. After the seal ring is cleaned, put it back.
- D. Attention: if the user finds it hard to put the seal ring back, use screwdriver press it carefully until it is done.



8.9 Regular check the safety valve. If the safety valve is become invalid, it must be replaced

Replace the safety valve:



(pic8)

- 1, Removing the the part 1 in pic8, then removing the pipe which connect the safety valve.
- 2, Removing the screw (part2 in pic8);
3. Replace the new safety valve.



The new safety valve must be the same model. If user can't find the same safety valve, please contact with seller or our service department.



Never maintain and repair the sterilizer until the power is disconnected and it is getting cool down for preventing scald. Repairing the sterilizer must be done by the well trained professionals.

9、 Transport and Storage

9.1 Preparation

Cool down the sterilizer and disconnect power.

9.2 Drainage

Empty all tanks: Insert the side of pipe without joint into bleeder valve, A is waste water tank bleeder valve, B is water storage tank bleeder valve. Then turn the drainage switch towards anti-clockwise.

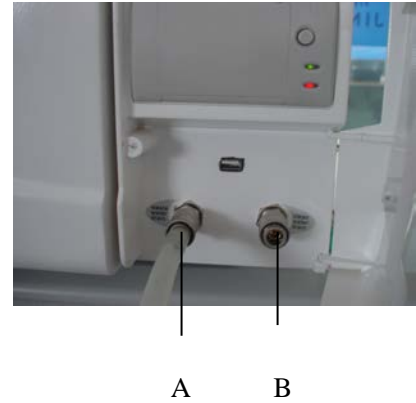

9.3 Terms of transportation:

Terms of transportation should according to the order contract.

9.4 Terms of store:

After packing, the sterilizer should keep in the clean indoor, which the temperature is 5°C~40°C, the relative humid is no more than 80%,no corroding gases and well-ventilated.



Don't drag during moving.

10、 Guarantee

1、 Warranty : 2 years.

2、 We will not offer free service even in the first year if the things happen as below:

- (1)The damage is caused by incorrect installation;
- (2)The damage is caused by fall down or impact by careless;
- (3)The damage is caused by customer's install or repair;
- (4) Without invoice and guarantee card;
- (5)The damage is caused by force majeure such as abnormal voltage, fire etc;

The damages are caused by the above reasons, we will still offer our service, but we will also charge appropriate fees.

11、 Accessories



1.Drainage pipe(YS-9-10-1)	1
2.Tray (see table 11.1)	3
3.Cable with plug(YS-9-12-2)	1
4. Tray shelf (see table 11.2)	1
5. Tray-hand-holder(YS-9-12-4)	1
6. Fuse(Φ 6X30 230V20A)	2
7. Manual	1

Table 11.1: parts for different models

Part \ Model	YS-12L-E	YS-18L-E	YS-22L-E
Tray	YS-2-6-1	YS-1-6-1	YS-3-6-1
Tray shelf	YS-2-6-2	YS-1-6-2	YS-3-6-2

Appendixes

Appendix1: Structure diagram:

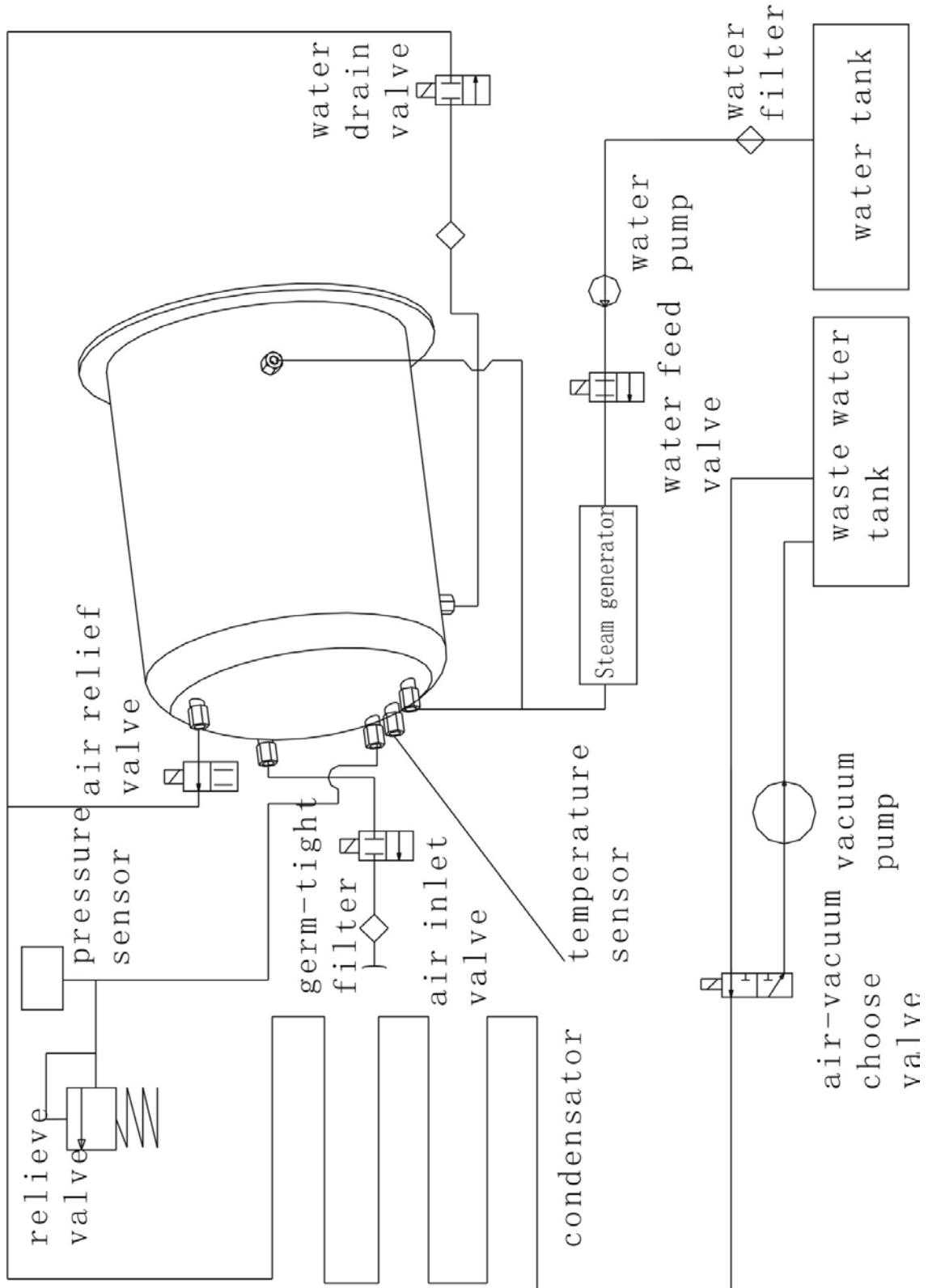

Appendix2: Circuit diagram

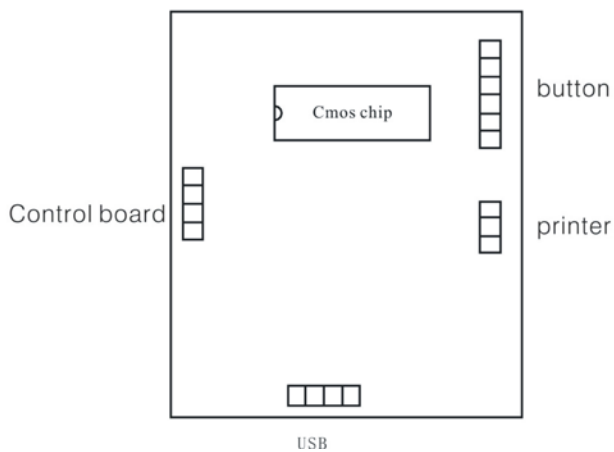
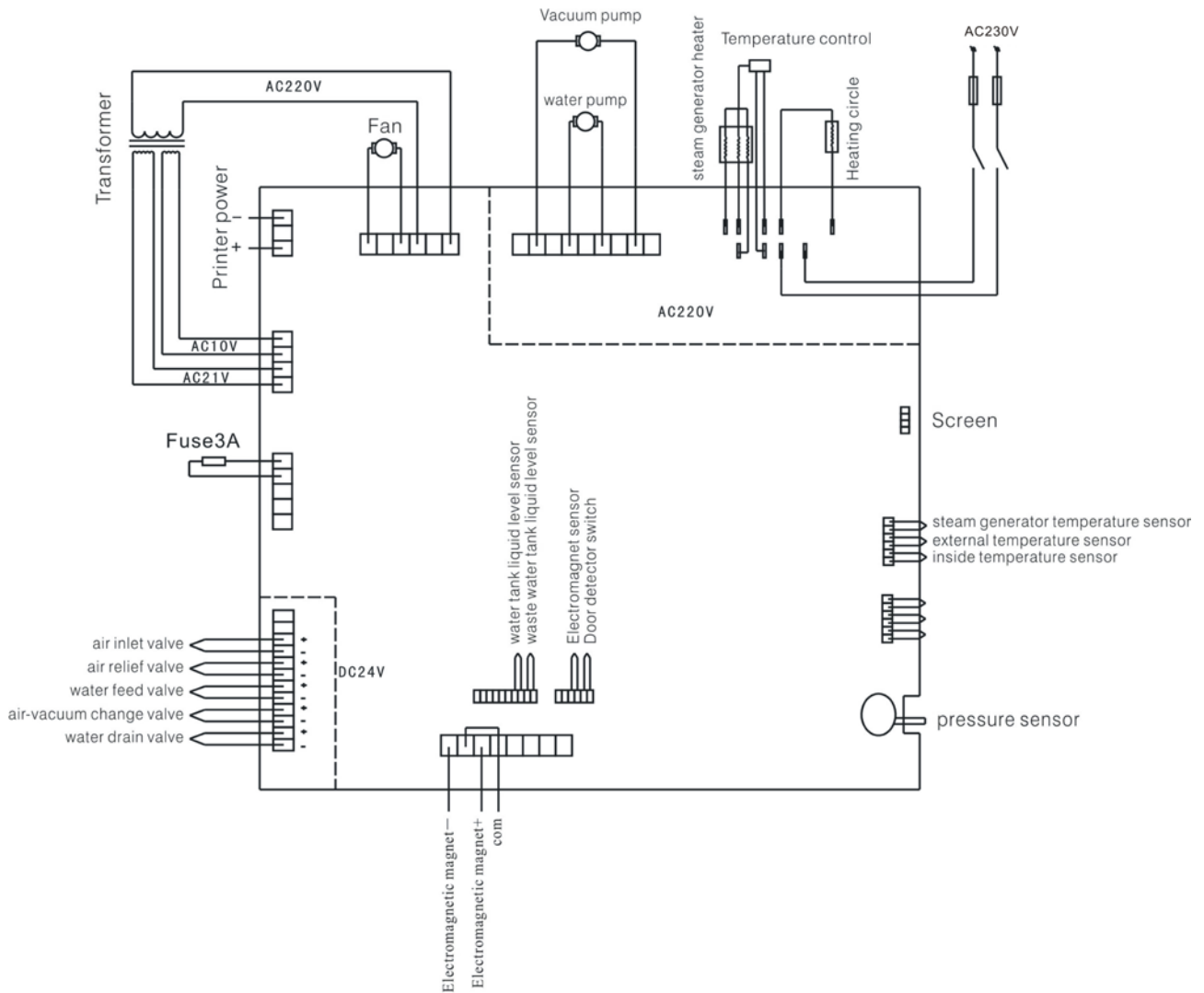

Vacuum pump power: AC: 230V 50Hz 70W
 Water pump power: AC: 230V 50Hz 47W
 Heating circle: AC: 230V 50Hz 1500W
 Heating rod: AC: 230V 50Hz 750W
 Electromagnetic valve: DC: 24V 5W

Appendix3: EMC

Electromagnetic emissions		
The Steam sterilizer is intended for use in the electromagnetic environment specified below. The customer or the user of the Steam sterilizer should assure that it is used in such an environment.		
Emissions test	Compliance	Electromagnetic environment – guidance
RF emissions CISPR 11	Group 1	The Steam sterilizer uses RF energy only for its internal function. Therefore, its RF emissions are very low and are not likely to cause any interference in nearby electronic equipment.
RF emissions CISPR 11	Class B	The Steam sterilizer is suitable for use in all establishments, including domestic establishments and those directly connected to the public low-voltage power supply network that supplies buildings used for domestic purposes.
Harmonic emissions IEC 61000-3-2	Class A	
Voltage fluctuations/ flicker emissions IEC 61000-3-3	Complies	

Electromagnetic immunity

The Steam sterilizer is intended for use in the electromagnetic environment specified below. The customer or the user of the Steam sterilizer should assure that it is used in such an environment.

Immunity test	IEC 60601 test level	Compliance level	Electromagnetic environment – guidance
Electrostatic discharge (ESD) IEC 61000-4-2	±6 kV contact ±8 kV air	±6 kV contact ±8 kV air	Floors should be wood, concrete or ceramic tile. If floors are covered with synthetic material, the relative humidity should be at least 30 %.
Electrical fast transient/burst IEC 61000-4-4	±2 kV for power supply lines ±1 kV for input/output lines	±2 kV for power supply lines ±1 kV for input/output lines	Mains power quality should be that of a typical commercial or hospital environment.
Surge IEC 61000-4-5	±1 kV line(s) to line(s) ±2 kV line(s) to earth	±1 kV line(s) to line(s) ±2 kV line(s) to earth	Mains power quality should be that of a typical commercial or hospital environment.
interruptions and voltage variations on power supply input lines IEC 61000-4-11	<5 % U_T (>95 % dip in U_T) for 0,5 cycle 40 % U_T (60 % dip in U_T) for 5 cycles 70 % U_T (30 % dip in U_T) for 25 cycles <5 % U_T (>95 % dip in U_T) for 5 sec	<5 % U_T (>95 % dip in U_T) for 0,5 cycle 40 % U_T (60 % dip in U_T) for 5 cycles 70 % U_T (30 % dip in U_T) for 25 cycles <5 % U_T (>95 % dip in U_T) for 5 sec	Mains power quality should be that of a typical commercial or hospital environment. If the user of the Steam sterilizer requires continued operation during power mains interruptions, it is recommended that the Steam sterilizer be powered from an uninterruptible power supply or a battery.
Power frequency (50/60 Hz) magnetic field IEC 61000-4-8	3 A/m	3 A/m	Power frequency magnetic fields should be at levels characteristic of a typical location in a typical commercial or hospital environment.

NOTE U_T is the a.c. mains voltage prior to application of the test level.

Electromagnetic immunity

The Steam sterilizer is intended for use in the electromagnetic environment specified below. The customer or the user of the Steam sterilizer should assure that it is used in such an environment.

Immunity test	IEC 60601 test level	Compliance level	Electromagnetic environment – guidance
Conducted RF IEC 61000-4-6	3 Vrms 150 kHz to 80 MHz	3 Vrms	Portable and mobile RF communications equipment should be used no closer to any part of the Steam sterilizer including cables, than the recommended separation distance calculated from the equation applicable to the frequency of the transmitter. Recommended separation distance $d = 1,2 \sqrt{P}$ $d = 1,2 \sqrt{P}$ 80 MHz to 800 MHz $d = 2,3 \sqrt{P}$ 800 MHz to 2,5 GHz where P is the maximum output power rating of the transmitter in watts (W) according to the transmitter manufacturer and d is the recommended separation distance in metres (m). Field strengths from fixed RF transmitters, as determined by an electromagnetic site survey, ^a should be less than the compliance level in each frequency range. ^b Interference may occur in the vicinity of equipment marked with the following symbol: 
Radiated RF IEC 61000-4-3	3 V/m 80 MHz to 2,5 GHz	3 V/m	

NOTE 1 At 80 MHz and 800 MHz, the higher frequency range applies.

NOTE 2 These guidelines may not apply in all situations. Electromagnetic propagation is affected by absorption and reflection from structures, objects and people.

^a Field strengths from fixed transmitters, such as base stations for radio (cellular/cordless) telephones and land mobile radios, amateur radio, AM and FM radio broadcast and TV broadcast cannot be predicted theoretically with accuracy. To assess the electromagnetic environment due to fixed RF transmitters, an electromagnetic site survey should be considered. If the measured field strength in the location in which the Steam sterilizer is used exceeds the applicable RF compliance level above, the Steam sterilizer should be observed to verify normal operation. If abnormal performance is observed, additional measures may be necessary, such as reorienting or relocating the Steam sterilizer.

^b Over the frequency range 150 kHz to 80 MHz, field strengths should be less than 3 V/m.

**Recommended separation distances between
portable and mobile RF communications equipment and the Steam sterilizer**

The Steam sterilizer is intended for use in an electromagnetic environment in which radiated RF disturbances are controlled. The customer or the user of the Steam sterilizer can help prevent electromagnetic interference by maintaining a minimum distance between portable and mobile RF communications equipment (transmitters) and the Steam sterilizer as recommended below, according to the maximum output power of the communications equipment.

Rated maximum output power of transmitter W	Separation distance according to frequency of transmitter m		
	150 kHz to 80 MHz $d = 1,2 \sqrt{P}$	80 MHz to 800 MHz $d = 1,2 \sqrt{P}$	800 MHz to 2,5 GHz $d = 2,3 \sqrt{P}$
0,01	0,12	0,12	0,23
0,1	0,38	0,38	0,73
1	1,2	1,2	2,3
10	3,8	3,8	7,3
100	12	12	23

For transmitters rated at a maximum output power not listed above, the recommended separation distance d in metres (m) can be estimated using the equation applicable to the frequency of the transmitter, where P is the maximum output power rating of the transmitter in watts (W) according to the transmitter manufacturer.

NOTE 1 At 80 MHz and 800 MHz, the separation distance for the higher frequency range applies.

NOTE 2 These guidelines may not apply in all situations. Electromagnetic propagation is affected by absorption and reflection from structures, objects and people.