

97055021
Rev. 03
2021-03

S Classic-17 / S Classic-22 / B Classic-17 / B Classic-22 / B Classic-28



 **CEFLA S.C.** VIA SELICE PROVINCIALE 23/A - 40026 IMOLA (BO) ITALY
PLANT: VIA BICOCCA 14/C - 40026 IMOLA (BO) - ITALY

EN

Contents

1. FOREWORD	4
1.1. SYMBOLS USED.....	4
1.2. SYMBOLS ON THE DEVICE.....	4
1.3. RELEVANT EUROPEAN DIRECTIVES.....	4
1.4. CLASSIFICATION.....	4
1.5. INTENDED USE.....	5
1.5.1. IMPORTANT NOTES.....	5
1.6. GENERAL WARNINGS.....	5
1.7. RESIDUAL RISKS.....	6
1.8. INFORMATION ON MITIGATION OF RESIDUAL RISKS.....	6
2. PACKAGE CONTENT	7
2.1. DIMENSIONS AND WEIGHT.....	7
2.2. DESCRIPTION OF THE CONTENT.....	8
2.3. PRODUCT HANDLING.....	9
2.4. CONDITIONS FOR STORAGE AND TRANSPORT.....	9
3. GENERAL DESCRIPTION - PRODUCT PRESENTATION	10
3.1. GENERAL CHARACTERISTICS.....	10
3.2. TECHNICAL SPECIFICATIONS.....	11
3.2.1. SUMMARY TABLE.....	11
3.3. SAFETY DEVICES.....	13
3.4. WATER SUPPLY CHARACTERISTICS.....	13
3.5. FRONT.....	14
3.6. REAR.....	15
3.7. LCD ICONS.....	16
3.8. EXAMPLE OF WORKING CYCLE.....	17
4. SETTING UP THE DEVICE	18
4.1. OVERALL DIMENSIONS.....	19
4.2. COMPARTMENT DIMENSIONS FOR BUILT-IN INSTALLATION.....	20
4.3. GENERAL PRECAUTIONS FOR INSTALLATION.....	20
4.4. POWER SUPPLY.....	20
4.5. ELECTRICAL CONNECTIONS.....	21
4.6. DIRECT CONNECTION TO A CENTRALIZED DRAINING POINT.....	21
5. FIRST START-UP	22
5.1. STARTING.....	22
5.2. MAIN MENU.....	23
5.3. FILLING DISTILLED WATER.....	23
5.3.1. MANUAL FILLING.....	23
5.3.2. AUTOMATIC FILLING.....	23
6. CONFIGURATION	24
6.1. SETTINGS.....	24
6.1.1. LANGUAGE.....	24
6.1.2. DATE AND TIME.....	25
6.1.3. USERS.....	25
6.1.3.1. USER DATA.....	26
6.1.3.2. PIN CHANGE BY ADMINISTRATOR.....	27
6.1.3.3. USERS LIST.....	28
6.1.3.4. PIN REQUEST.....	29
6.1.3.5. DELETE USERS.....	31
6.1.4. PREHEATING.....	32
6.1.5. WATER FILLING.....	33
6.1.6. DISPLAY.....	34
6.1.7. TEST REMINDER.....	34
6.1.8. SERVICE.....	34
7. PREPARATION OF THE MATERIAL	35
7.1. TREATING THE MATERIAL BEFORE STERILIZATION.....	35
7.2. ARRANGING THE LOAD.....	35
7.3. POSITIONING AND USE OF TRAY HOLDER SUPPORT.....	38
8. STERILIZATION CYCLES	40
8.1. EXTRA DRYING.....	41
8.2. DELAY START.....	42
8.3. EXECUTION OF THE CYCLE.....	43
8.4. CYCLE OUTCOME.....	43
8.5. DOOR OPENING AT THE END OF THE CYCLE.....	43
8.6. USER-DEFINED CYCLE.....	44
9. MATERIAL STORAGE	45
10. TEST PROGRAMS	46
10.1. HELIX TEST/B-D CYCLE.....	46

10.2. VACUUM TEST CYCLE.....	47
10.3. VACUUM + B-D TEST CYCLE.....	48
10.4. H2O TEST	48
10.5. DOOR OPENING.....	50
10.6. MANUAL INTERRUPTION.....	51
11. USED WATER DRAIN.....	52
12. DATA MANAGEMENT	53
12.1. PRINT MANAGEMENT	53
12.2. PRINT LABELS.....	54
12.3. DOWN. CYCLE DATA	55
12.4. WIFI	56
12.5. ETHERNET.....	59
12.5.1. CONNECTION TO A LOCAL NETWORK EQUIPPED WITH DHCP SERVER, WITH STERILISER CONFIGURED WITH STATIC IP59	
12.5.2. CONNECTION TO A LOCAL NETWORK MANUALLY CONFIGURED WITH "STATIC" IPs	60
13. APPENDIX – PROGRAMS	61
13.1. SUMMARY TABLE OF S 17 220 V - 240 V CYCLES	62
13.2. SUMMARY TABLE OF S 22 220 V - 240 V CYCLES	63
13.3. SUMMARY TABLE OF 17 220 V - 240 V CYCLES	64
13.4. SUMMARY TABLE OF 17 120 V CYCLES.....	66
13.5. SUMMARY TABLE OF 22 220 V - 240 V CYCLES	68
13.6. SUMMARY TABLE OF 22 120 V CYCLES.....	70
13.7. SUMMARY TABLE OF 28 220 V - 240 V CYCLES	72
13.8. SUMMARY TABLE OF 28 120 V CYCLES.....	74
13.9. STERILISATION PROGRAM DIAGRAM.....	77
13.10. DIAGRAMS OF THE TEST PROGRAMMES	79
14. APPENDIX - MAINTENANCE.....	80
14.1. ORDINARY MAINTENANCE PROGRAMME	80
14.2. SCHEDULED MAINTENANCE MESSAGES.....	81
14.3. DESCRIPTION OF MAINTENANCE INTERVENTIONS.....	82
14.3.1. CLEAN GASKET AND PORTHOLE	82
14.3.2. CLEAN STERILIZATION CHAMBER AND ACCESSORIES.....	82
14.3.3. EXTERNAL SURFACE CLEANING AND DISINFECTION	82
14.3.4. CLEANING AND DISINFECTION OF FILTERS AND TANK.....	82
14.3.5. BOILER FILTER CLEANING	82
14.3.6. DOOR LOCK LUBRICATION	82
14.3.7. ANTI-DUST FILTER CLEANING	83
14.3.8. REPLACE THE BACTERIOLOGICAL FILTER	83
14.3.9. WATER TANK CLEANING	83
14.3.10. BOILER GASKET REPLACEMENT	83
14.4. PERIODIC STERILIZER VALIDATION	83
14.5. DEVICE USEFUL LIFE	84
14.6. DISPOSING THE EQUIPMENT WHEN NO LONGER USED	84
15. APPENDIX - GENERAL PROBLEMS.....	85
15.1. TROUBLESHOOTING	85
16. APPENDIX – ALARMS.....	87
16.1. ALARM INTERVENTION	87
16.2. ALARM DURING A CYCLE.....	87
16.3. SYSTEM RESET	88
17. ALARM CODES.....	89
17.1. ERRORS (CATEGORY E)	89
17.2. ALARMS (CATEGORY A).....	91
17.3. HAZARDS (CATEGORY H)	93
17.4. SYSTEM ERRORS (CATEGORY S).....	94
17.5. TROUBLESHOOTING	94
17.5.1. ERRORS (CATEGORY E)	94
17.5.2. ALARMS (CATEGORY A).....	98
17.5.3. HAZARDS (CATEGORY H)	101
17.5.4. SYSTEM ERRORS (CATEGORY S).....	102
18. USER PIN RESET	103
19. APPENDIX - ACCESSORIES.....	104
20. PRINTER CONNECTION.....	106
21. APPENDIX - SPARE PARTS AND ACCESSORIES.....	107
22. APPENDIX - TECHNICAL SERVICE.....	108
23. APPENDIX - WARNINGS AND LOCAL REGULATIONS.....	109

1. FOREWORD

The instructions inform the user on how to properly operate the device. It is extremely important to read this manual carefully and thoroughly before using the device.

This publication must not be reproduced, copied or transferred in any manner (electronically, mechanically, via photocopies, translations or other means) without the prior written consent of the manufacturer.









The manufacturer has a company policy of continual development. Therefore, some of the instructions, specifications and figures given in this manual may slightly differ from the purchased product. The manufacturer reserves the right to make changes to this manual without giving prior notice.

The original text is in Italian; this is a translation from the original in Italian.

1.1. SYMBOLS USED

	<p>NOTE: Pay particular attention to the paragraphs marked with the symbol shown.</p>		<p>CAUTION: Potential danger for people, environment and property. Follow the procedures indicated in the manual to prevent potential damage to materials, devices and/or property.</p>
--	--	---	--

1.2. SYMBOLS ON THE DEVICE

	<p>Potential danger due to high temperature.</p>		<p>Disposal symbol in accordance with Directive 2012/19/EU.</p>
	<p>Device in compliance with essential requirements of Directive 93/42/EU and subsequent modifications. Notified body: IMQ spa</p>		<p>Refer to the user manual.</p>
	<p>Device compliant with the requirements set out in the Directive 2014/68/EU (PED) - category I for 17 I sterilizers; category II for 22 and 28 I sterilizers. Notified body: Rina Services S.p.A.</p>		<p>Ukrainian national symbol of conformity.</p>
	<p>ON/OFF switch.</p>	<p>UA.TR.101</p> 	<p>Fuses 2xT15A 250V.</p>

1.3. RELEVANT EUROPEAN DIRECTIVES

The product described in this manual is manufactured in accordance with the highest safety standards and doesn't represent any danger for the operator if used according to the following instructions. The product is **complying** with the following **European Directives as applicable**:

93/42/EEC, and subsequent amendments and additions, concerning medical devices.
2011/65/EU, (RoHS II) on restriction of hazardous substances in electrical and electronic devices.
2014/68/EU, (PED).

The product complies with Standard **EN 13060:2014 + A1:2018**.

1.4. CLASSIFICATION

Classification of the device according to the rules indicated in Annex IX of Directive 93/42/EEC and subsequent modifications and integrations: **CLASS IIB**.

1.5. INTENDED USE

The product described in this manual is only intended for sterilization of reusable surgical instruments and materials.

DEVICE INTENDED FOR PROFESSIONAL USE

 The use of the device is strictly reserved to qualified personnel. It must never be used or handled by untrained and/or unauthorised persons.

The device must not be used for the sterilization of fluids, liquids or pharmaceutical products.

 The sterilizer is not a mobile or portable device

1.5.1. IMPORTANT NOTES

 Information contained in this manual are subject to change without notice.
The manufacturer is not responsible for direct, indirect or accidental damage resulting from or relating to the provision or use of this information.
This document may not be reproduced, adapted or translated, in part or in full, without the prior written permission of the manufacturer.

1.6. GENERAL WARNINGS

When using this product, **always** follow the instructions in the manual and never use it for anything other than its intended purpose.

 The user is responsible for any legal requirements relating to the installation and use of the product. The manufacturer will not be held responsible for any breakage, malfunction, property damage or injury to people in the event that the product is not installed or used correctly, or proper maintenance is not carried out.

Please observe the following precautions in order to avoid injury or property damage:

- Use ONLY demineralised and/or distilled water of high quality.

 The use of water of inadequate quality can severely damage the device. See technical characteristics appendix in this regard.

- Do not pour water or other fluids on the device;
- Do not pour flammable substances on the device;
- Do not use the system in the presence of flammable or explosive gases or vapours;
- Before performing any maintenance or cleaning intervention, **ALWAYS DISCONNECT** power supply;

 Whenever it is not possible to disconnect the power supply from the device, or if the external mains switch is distant or not visible to the maintenance technician, place a “work in progress” sign on the external mains switch after having turned it off.

- Make sure the electrical system is grounded according to current laws and/or standards;
- Do not remove any label or nameplate from the device; request new ones, if necessary;
- Use only original spare parts.

 Failure to comply with the above exempts the manufacturer from all liability.

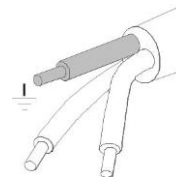
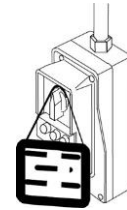

1.7. RESIDUAL RISKS

FOR THE USER

- Contamination due to improper handling of the load;
- Burn by contact with hot surfaces or fluids.

FOR THE PATIENT

- Contamination due to unsterilised material caused by wrong cleaning treatment before sterilization;
- Contamination due to implementation of a wrong reuse process;
- Contamination due to material unsuitable to sterilization or not compliant with instructions for use;
- Contamination due to unsterilised material caused by wrong final assessment of sterilization process;
- Contamination due to missing or wrong scheduled maintenance;
- Contamination due to missing periodic validation.

1.8. INFORMATION ON MITIGATION OF RESIDUAL RISKS

FOR THE USER

Contamination due to improper handling of the load.

See chapter PREPARING THE MATERIAL.

Burn by contact with hot surfaces or fluids.

To extract the sterile material, once the sterilization process has been completed with saturated steam at 121° or 134°, proceed as follows:

- Always wear PPE suitable for the handling of hot material and gloves of appropriate material and thickness;
- Clean your gloved hands with a germicide detergent;
- Always use the special tool, supplied as standard, to extract the trays from the sterilization chamber;
- Avoid any contact of trays and material with contaminated and/or non-heat-resistant surfaces;
- Handle the sterile material making sure not to damage any packages, bags and containers serving as a barrier.

FOR THE PATIENT

Contamination due to unsterilised material caused by wrong cleaning treatment before sterilization.

See chapter TREATING THE MATERIAL BEFORE STERILIZATION.

Contamination due to implementation of a wrong reuse process.

Make sure to use sterile material.

Contamination due to material unsuitable to sterilization or not compliant with instructions for use.

- Check that the contaminated material is compatible with the selected sterilization process;
- Immediately separate the materials to be sterilized from those that must not be subjected to such process or are not able to withstand it.

Contamination due to unsterilised material caused by wrong final assessment of sterilization process.

The sterilization process electronic control system monitors the various phases, at the same time checking that the various parameters are respected; if any type of anomaly is encountered during the cycle, the program is immediately interrupted, generating an alarm identified by a code, with a relative message explaining the nature of the problem.

Furthermore, the sterilization process can be checked by means of:

CHEMICAL INDICATORS

that monitor the sterilization process by providing information, together with the control of physical and biological parameters, on the conditions occurred in the sterilization chamber during the process.

The final toning of the process indicator does not certify that the product is sterile but only that the device has been subjected to a sterilization process. If the toning does not occur, the operator in charge of releasing the sterile material, that must not be used, must find out why.

PHYSICAL INDICATORS

They include the reading of machine data and the execution of specific tests indicated during the validation phase for that specific cycle/load/autoclave. This control system can include:

- Direct reading of the synoptic system (thermometer, pressure gauge, recorder, etc.);
- Reading of prints/labels/files on which the data detected by the synoptic system are stored (parameters);
- Execution of specific tests (vacuum test, Bowie-Dick test, Helix test).

The operator in charge of the process certifies the validity of the load at the end of every cycle by means of the parametric release.

Contamination due to missing or wrong scheduled maintenance.

The sterilizer, based on a preset programming, displays a warning message relating to the scheduled maintenance necessary to ensure the good operation of the device.

Contamination due to missing periodic validation.

See chapter PERIODIC STERILIZER VALIDATION.

2. PACKAGE CONTENT

Check the integrity of the product package upon receipt.

2.1. DIMENSIONS AND WEIGHT

Once the package is opened, check that:

- The supply matches the specifications of the order (see the delivery note);
- There is no visible damage to the product.

Dimensions and weight	
A Height	600 mm
B Width	600 mm
C Depth	700 mm
Total weight	65 kg

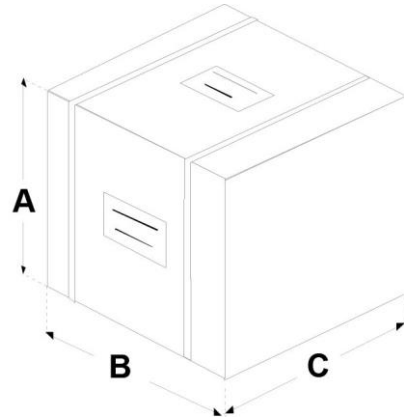

In case of wrong delivery, missing parts or any type of damage, inform immediately and in detail the reseller and the carrier that made the delivery.

2.2. DESCRIPTION OF THE CONTENT

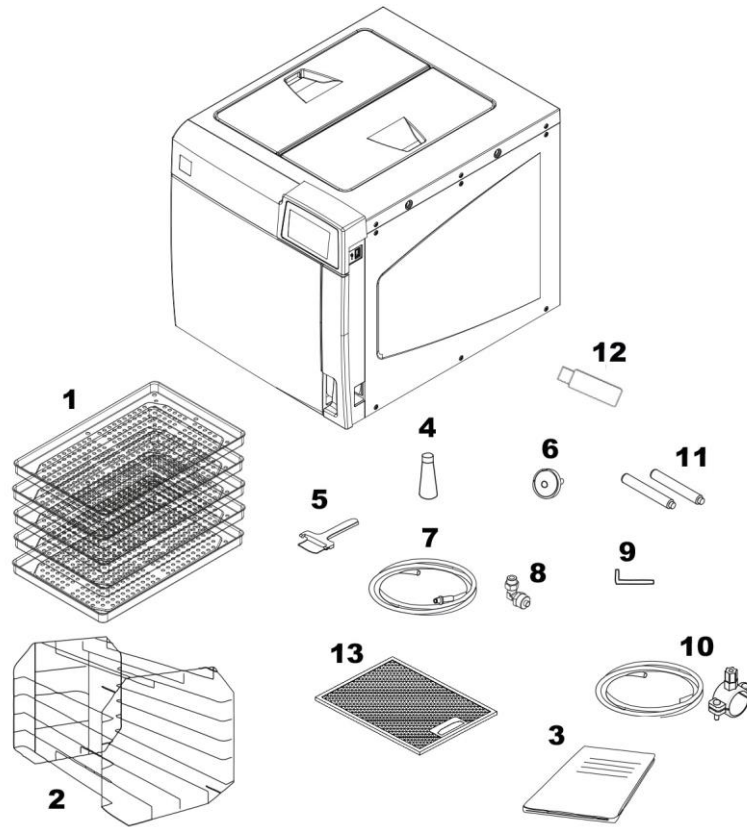

In addition to the sterilizer, the package contains:

- | | |
|--|--|
| <p>1 Instrument trays:</p> <ul style="list-style-type: none"> - 3 pcs for S 17 and S 22; For the other versions: - 5 pcs for B 17 and B 22; - 6 pcs for B 28; | <p>7 Rubber hose with quick coupling for manual water drainage;</p> |
| <p>2 Tray holder support;</p> | <p>8 Angled union + straight union;</p> |
| <p>3 Operator's documentation and safety valve's EC Declaration of Conformity;</p> | <p>9 Allen wrench (for door manual unlocking);</p> |
| <p>4 Lubricant for door locking mechanism;</p> | <p>10 Plastic tube for direct water drainage, with fastening clamp;</p> |
| <p>5 Tray extractor;</p> | <p>11 Rear spacers
(Not provided for S versions);</p> |
| <p>6 Additional bacteriological filter
(Not provided for S versions);</p> | <p>12 USB key containing:
User manual and DataSter Software.</p> |
| | <p>13 Dust filter.</p> |

2.3. PRODUCT HANDLING

The packed product must be handled using, where possible, suitable mechanical means (lift truck, pallet truck, etc.) and following the indications on the package.

In case of manual handling, the product must be lifted by two persons using the suitable available means.

Once the sterilizer has been removed from the package, it must be lifted by two persons using the suitable available means and handled, if possible, using a truck or similar means.

 **We recommend to transport and store the device at a temperature not below 5°C. Extended exposure to low temperatures may damage the product.**

 *Store the original package and use it for any transport of the device. Using a different package may damage the product during shipping.*

 **Before transport, leave the device turned off for about 30 minutes after the last program finishes and drain the distilled water and used water tanks so that all the internal parts will have time to cool down.**

2.4. CONDITIONS FOR STORAGE AND TRANSPORT

TEMPERATURE: between +5° C and +70° C

HUMIDITY: between 20% and 80%

PRESSURE: between 0.5 and 1.1 bar (50 and 110 kPa)

3. GENERAL DESCRIPTION - PRODUCT PRESENTATION

3.1. GENERAL CHARACTERISTICS

The device is an electronic water steam sterilizer, entirely operated by a micro-processor, with a large, printed stainless steel sterilization chamber. It is characterized by an advanced fractionated vacuum system for the complete removal of air, even from hollow, porous materials, and an effective final vacuum drying phase capable of eliminating all traces of humidity from any load.

The exclusive steam generation system, the effective hydraulic circuit and the electronic management (integrated by high-precision sensors) ensure a high execution speed of the process and an excellent stability of thermodynamic parameters. Moreover, its Process Evaluation System constantly monitors all the machine's "vital" parameters in real-time, guaranteeing absolute safety and a perfect result.

The device offers users 6 sterilization programs (one of which completely programmable), all equipped with customisable, optimised drying for the fast, effective sterilization of the various types of load (instruments and materials) used in a medical environment. All the cycles can immediately be selected on the clear LCD screen, which also allows extensive configuration of the device according to the user's needs.

Like in the best tradition, also the new range of autoclaves features the most complete and advanced safety systems available today, to ensure the user against any operation, electrical, mechanical, thermal or functional fault.



For the description of safety devices, refer to technical characteristics appendix.

3.2. TECHNICAL SPECIFICATIONS

3.2.1. SUMMARY TABLE

Device	WATER STEAM STERILIZER				
	S 17	S 22	17	22	28
Class (according to Directive 93/42/EEC and subsequent amendments)	IIb				
Manufacturer	CEFLA s.c. Headquarters Via Selice Provinciale 23/A – 40026 Imola (BO) IT				
Input voltage	220 V - 240 V~ 50 Hz 220 V - 240 V~ 60 Hz		220 V - 240 V~ 50 Hz 220 V - 240 V~ 60 Hz 120V~ 60 Hz		
Network fuses (6.3 x 32 mm)	2x T15A 250V				
Electronic board fuses (5 x 20 mm)	F1: T3.15A 250V (transformer primary 220 V - 240 V~ 50 Hz 220 V - 240 V~ 60 Hz) F2: T 3.15A 250V (transformer primary 120V~ 60 Hz)				
Nominal power	2300 W		2300 W 1440 W (120V~ / 60 Hz)		
Insulation class	Class I				
Installation category (according to EN 61010)	Cat. II				
Operational environment	Indoor use HUMID LOCATION (EN 61010 extended environmental conditions)				
A-weighted sound power level (ISO 3746)	< 67 db (A)				
Degree of protection (IP code) (EN 60529:1991+A1:2000+A2:2013)	IP21				
Environmental operating conditions	Temperature: +15°C ÷ +35°C Relative humidity: between 20% and 80% max non-condensing		Altitude: min -100 m / max. 3000 m (a.s.l.)		
External dimensions (HxWxD) (rear connections excluded)	480 x 500 x 600 mm				
Net weight: unladen unladen, with tray holder support and trays unladen, with tray holder support, trays and water at MAX level	approx. 47 kg approx. 50 kg approx. 53 kg	approx. 49 kg approx. 51 kg approx. 54 kg	approx. 48 kg approx. 50 kg approx. 54 kg	approx. 49 kg approx. 51 kg approx. 55 kg	approx. 50 kg approx. 52 kg approx. 56 kg
Sterilization chamber dimensions (D x D)	250 x 350 mm	250 x 450 mm	250 x 350 mm	250 x 450 mm	280 x 450 mm
Sterilization chamber total volume	approx. 17 l (0.017 cu. m)	approx. 22 l (0.022 cu. m)	approx. 17 l (0.017 cu. m)	approx. 22 l (0.022 cu. m)	approx. 28 l (0.028 cu. m)
Sterilization chamber usable volume (with tray holder support inserted)	approx. 10 l (0.010 cu. m)	approx. 13 l (0.013 cu. m)	approx. 10 l (0.010 cu. m)	approx. 13 l (0.013 cu. m)	approx. 19 l (0.019 cu. m)
Sterilization chamber usable dimensions	17 l (1.38x1.55x2.97) dm / 6.4 cu. dm		22 l (1.38x1.55x3.97) dm / 8.5 cu. dm		28 l (1.72x1.66x3.96) dm / 11.3 cu. dm
Distilled water tank capacity (filling)	approx. 5.5 l (water at MAX level) approx. 1 l (water at MIN level)				
Sterilization programs	5 standard programs + 1 program defined by the user				
Test programs	Helix/BD Test (not provided for S versions) Vacuum Test Vacuum Test+Helix/BD Test (not provided for S versions)				
Pre-heating time (from cold)	approx. 10 min				
USB connection	Stick capacity lower than or equal to 2GB: FAT formatting with 16K/sector Stick capacity higher than 2GB: FAT32 formatting with 16K/sector				

Device	WATER STEAM STERILIZER				
	S 17	S 22	17	22	28
Printer connection	Serial RS232 (printer cable max length 2.5 m)				
Printer insulation class:	Class I or Class II				
Printer power supply standard:	Compliant with Standard EN 60950. (The safety of the sterilizer may be compromised in case of uncertified printer power supply unit)				
120 V 60 Hz Main power cord	NEMA 5-15 plug 125 V-15A SJT cable 14 AWG / 3C STYLE 1015 60 ° C C19 connector according to IEC 60320				
220-240 V 50 Hz Main power cord	Plug CEE 7 / VII IEC 250V-16A 50 Hz 3x1.5 sq.mm cable from -25 to 70° C C19 connector according to IEC 60320 UL 498, CSA C22.2				
220 V 60 Hz Main power cord:	NEMA 6-15P plug 250V-15A SJT 14 AWG / 3C 300V 60° C C19 connector according to IEC 60320				
Ethernet connection	RJ45 (max. cable length 29 m)				
Wi-Fi	802.11 b/g/n (2.4 Ghz); WEP / WPA / WPA2-PSK encryption				
Bacteriological filter (filter element in PTFE)	Porosity: 0.027 microns Connection: male connector 1/8" NPT				
Maximum flow of drained water	1 l/min.				
Temperature of drained water	50° C				
Maximum temperature of drained water	90° C				
Total heat in Joule sent by the sterilizer to the surrounding air in 1 hour of continue operation	17 l = 3.6 MJ		22 l = 4 MJ		28 l = 5.4 MJ
Manoeuvre/handling space	1 m x 1 m				

Device	17	22	28
Class (according to Directive 2014/68/EU PED)	Category I	Category II	Category II
Working pressure	-0.8 ÷ 2.4 barg	-0.8 ÷ 2.4 barg	-0.8 ÷ 2.4 barg
Safety device set	2.4 barg	2.4 barg	2.4 barg
PT	500 kPa (abs)	500 kPa (abs)	500 kPa (abs)
PS	2.4 barg	2.4 barg	2.4 barg
TS	10 ÷ 140 °C	10 ÷ 140 °C	10 ÷ 140 °C
Fluid Group	2	2	2

3.3. SAFETY DEVICES

The sterilizer is equipped with the following safety devices for which we provide a brief description of their function:

- **Mains fuses** (see data in summary table)
Protection of the whole device against possible failures of heating elements.
Action: power supply interruption.
- **Electronic circuit protection fuses** (see data in summary table)
Protection against possible failures of the primary circuit of the transformer and of low voltage users.
Action: interruption of one or more low voltage circuits.
- **Thermal circuit-breakers on mains voltage windings**
Protection against possible overheating of pump motors and of transformer primary winding.
Action: temporary cut-off (until cooling) of the winding.
- **Safety valve**
Protection against overpressure in the sterilization chamber.
Action: release of the steam and restoration of the safety pressure.
- **Safety thermostat with steam generator manual reset**
Protection against steam generator overheating.
Action: cut-off of the electricity to the steam generator.
- **Safety thermostat with chamber heating element manual reset**
Protection against overheating of the heating elements of the container under pressure.
Action: cut-off of the electricity to the chamber heating element.
- **Door position safety microswitch**
Confirmation of the correct closing position of the door of the container under pressure.
Action: signalling of wrong door position.
- **Motor-driven door lock mechanism with electromechanical protection (pressure switch)**
Protection against accidental opening of the door (even in a blackout).
Action: prevents accidental opening of the door during a program.
- **Door locking mechanism safety microswitch**
Striker for the correct closing position of door locking system.
Action: signalling of failed or wrong operation of door locking mechanism.
- **Self-levelling hydraulic system**
Plumbing system structure for the spontaneous levelling of the pressure in the case of a manual interruption of the cycle, alarm or blackout.
Action: automatic restoration of atmospheric pressure in the sterilization chamber.
- **Integrated system for evaluating the sterilization process**
Continuous verification of the sterilization process parameters entirely managed by microprocessor.
Action: immediate interruption of the program (in case of malfunction) and generation of alarms.
- **Sterilizer operation monitoring**
Real-time oversight of all significant parameters when the machine is powered.
Action: generation of alarm messages (in the case of anomaly) with possible interruption of the cycle.

3.4. WATER SUPPLY CHARACTERISTICS

DESCRIPTION	VALUES IN THE WATER SUPPLY	VALUES INSIDE RESIDUAL
DRY CONDENSATE	< 10 mg/l	< 1 mg/l
SILICON OXIDE SiO ₂	< 1 mg/l	< 0.1 mg/l
IRON	< 0.2 mg/l l	< 0.1 mg/
CADMIUM	< 0.005 mg/l	< 0.005 mg/l
LEAD	< 0.05 mg/l	< 0.05 mg/l
HEAVY METAL RESIDUES (iron, cadmium and lead excluded)	< 0.1 mg/l	< 0.1 mg/l
CHLORIDES	< 2 mg/l	< 0.1 mg/l
PHOSPHATES	< 0.5 mg/l	< 0.1 mg/l
CONDUCTIVITY AT 20°C	< 15 µS/cm	< 3 µS/cm
pH VALUE	5 - 7	5 - 7
ASPECT	colourless, transparent, without sediment	colourless, transparent, without sediment
HARDNESS	< 0.02 mmol/l	< 0.02 mmol/l

When buying distilled water, make always sure that the quality and characteristics declared by the manufacturer are compatible with those specified in the table.

The use of water for steam generation with contaminant levels exceeding those indicated in the above table can greatly shorten the sterilizer lifetime.
This could also result in an increase of oxidation in the most sensitive materials as well as in an increase of limescale residues on generator, boiler, internal supports, trays and instruments.

3.5. FRONT

- 1 Model
- 2 Control panel and LCD screen
- 3 Door
- 4 Power switch
- 5 Dust filter

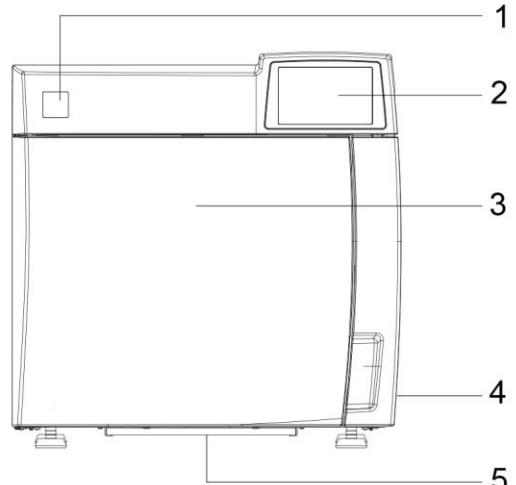

- 1 Sterilization chamber
- 2 Bacteriological filter
- 3 Door locking system
- 4 Water drainage filter
- 5 Distilled water top-up quick coupling
- 6 Distilled water drainage quick coupling
- 7 Waste water drainage quick connector
- 8 Door
- 9 Steam diffuser

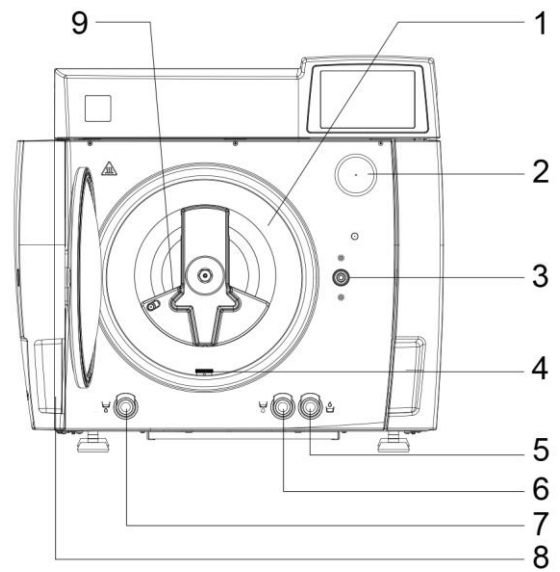

3.6. REAR

- 1 Fastening slots for rear spacers
- 2 Heat exchanger
- 3 Connection for direct water drainage
- 4 Connection for automatic distilled water filling (only for PURE 100 / 500, EV AUX kit and external pump kit)
- 5 Data plate
SERIAL NUMBER LABEL
(See image *)
- 6 Ethernet cable connection (max length 29 m)
- 7 Serial cable connection
- 8 Automatic filling electrical connection (only for PURE 100 / 500, EV AUX kit and external pump kit)
- 9 Network fuses
- 10 Power cable connection

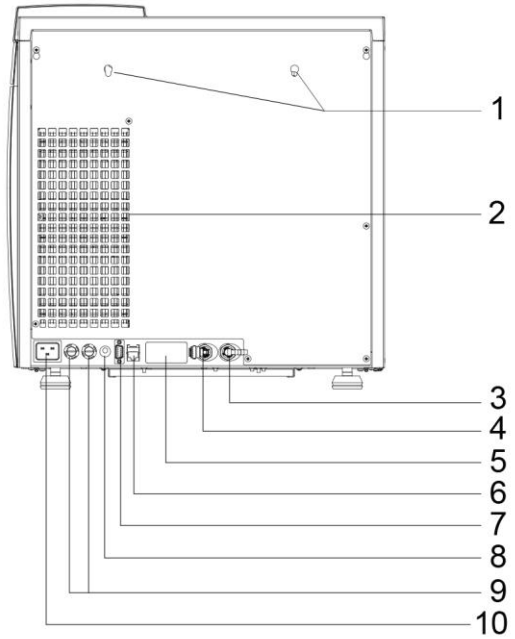

(*)

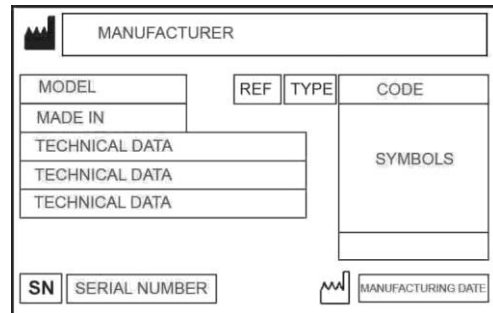

3.7. LCD ICONS

The screens in the following pictures may vary in shapes and colours, but their contents are the same as shown on the sterilizer display.

- A** Cycle counter
- B** Selection for data management
- C** Selection of sterilization and test cycles
- D** Date
- E** Time
- F** Door opening
- G** Selection of the sterilizer settings (Setup)
- H** Menu selection button
- I** Info button
- L** Confirmation Button
- M** Hidden information button (reserved to Service)

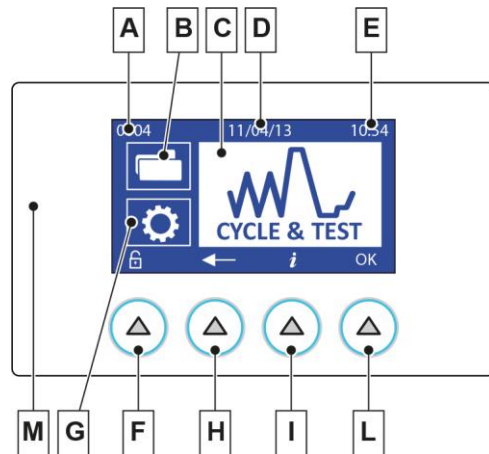

If the hidden information button (M) is pressed unintentionally, information on the device is displayed.
 To exit the screen, press the hidden information button again.
 This button is used during service operation.

Other particular symbols relating to the various conditions of use will be described in the relative paragraphs.

3.8. EXAMPLE OF WORKING CYCLE

The sterilization program can be effectively described as a succession of phases, each one with a very precise objective.

For example, the universal program (cycle B, 134°C - 4'): after loading the material in the chamber, closing the door, selecting the program and starting the cycle (after locking the door opening mechanism), the following sequence will be suggested (see the graph below):

- 1 Preheating the generator and sterilization chamber;
- 2 Removing the air and penetration of steam in the material through a series of vacuum (extraction of the fluid from the sterilization chamber) and pressure (injection of steam into the chamber) phases;
- 3 Raising the pressure, with the consequent increase in the temperature of the steam, until reaching the conditions required for sterilization (in the example, 134°C);
- 4 Stabilizing the pressure and temperature;
- 5 Sterilizing for the required time (in the example, 4 minutes);
- 6 Depressurizing the sterilization chamber;
- 7 Vacuum-drying phase;
- 8 Ventilating the load with sterile air;
- 9 Bringing the pressure of the sterilization chamber back to the atmospheric level.

Having reached this last phase, you can unlock the door and remove the load from the sterilization chamber.

It should be emphasized that phases 1, 3, 4, 6 and 9 are identical in all cycles, with slight variations of duration that are solely dependent on the quantity and consistency of the load and the heating conditions of the sterilizer while phases 2, 5, 7 and 8 clearly vary their configuration and/or duration on the basis of the cycle selected (and, as a consequence, the type of load) and the choices made by the user.

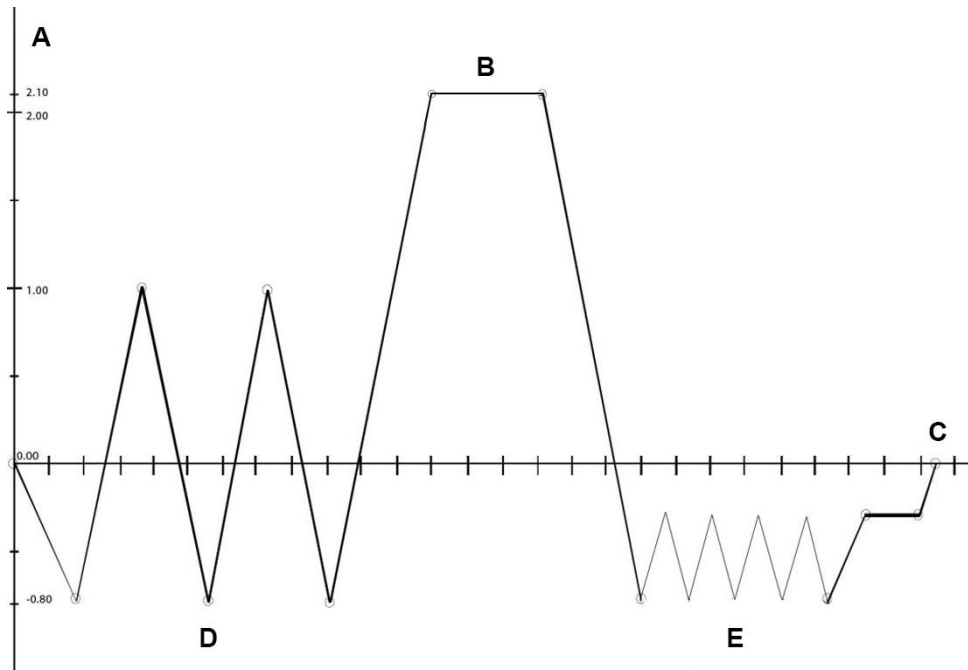

- A PRESSURE (BAR)
- B PROCESS
- C TIME (MIN)
- D FRACTIONATED VACUUM
- E VACUUM DRYING

Please refer to the programs appendix for more details on programs.

4. SETTING UP THE DEVICE



The safety of every system which integrates the device is responsibility of the system assembler.

The first and essential step for a proper operation of the sterilizer, its durability over time and complete use of its features is a correct and careful commissioning. Moreover, this precaution will avoid the danger of physical injury or property damage, not to mention malfunctions and damage to the device.

Please follow **meticulously** the instructions contained hereafter in this chapter.

 *Technical service department (see appendix) is available for any doubt or further information. The sterilizer is placed on the marked only after having passed all the checks required. It does not require any additional calibration for commissioning.*

Dimensions and weight	S 17	S 22	17	22	28
A Height (total)	500 mm				
B Width (total)	480 mm				
C Depth (excluding rear connections)	600 mm				
Total weight	50 kg	51 kg	50 kg	51 kg	52 kg

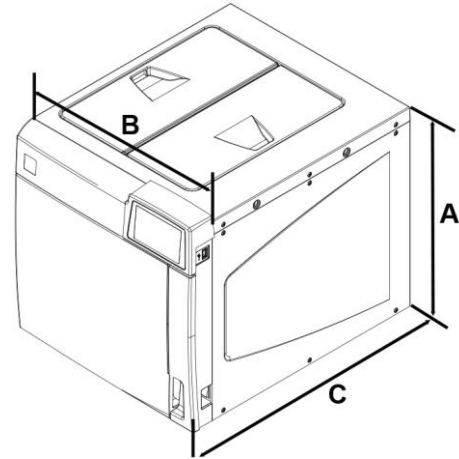

4.1. OVERALL DIMENSIONS

Centre distance and maximum overall dimensions of the sterilizer feet, with and without rear spacers.

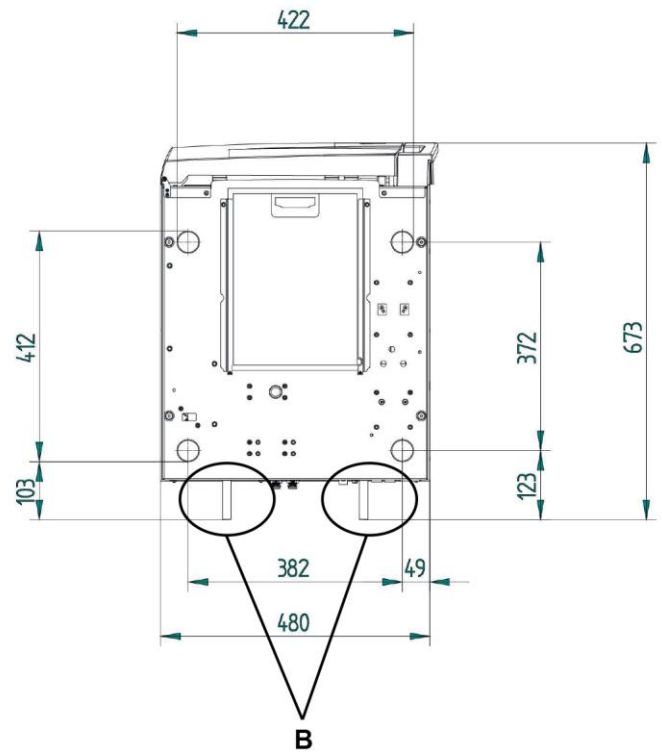
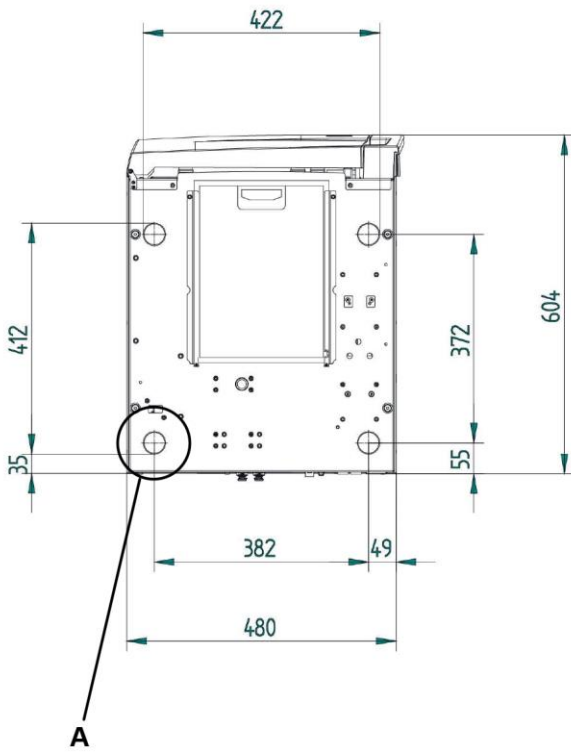

- A Feet
- B Rear spacers

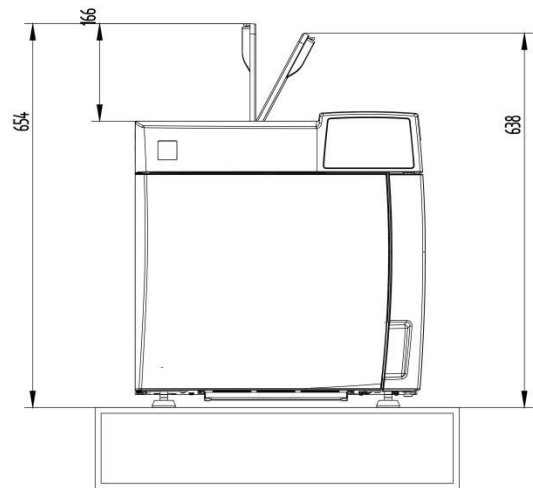
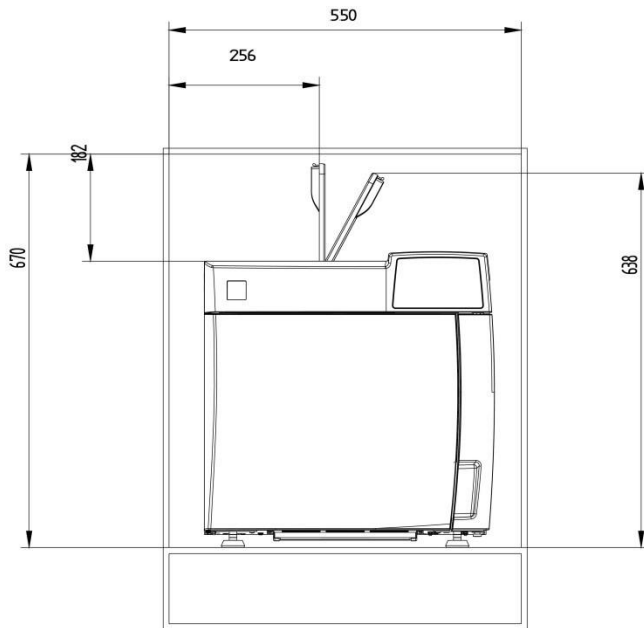

4.2. COMPARTMENT DIMENSIONS FOR BUILT-IN INSTALLATION

When installing the sterilizer inside a cabinet, you must provide adequate space all around the device to provide effective ventilation as well as an opening in the back (180 sq.cm) that, in addition to allowing the passage of the power cord, will also provide an adequate air flow and the consequent optimum cooling of the heat exchanger.

 Mount the rear spacers supplied to ensure that the sterilizer is placed at the correct distance from the wall.

The compartment where the sterilizer will be installed must have the following minimum dimensions:

COMPARTMENT DIMENSIONS	CHAMBER VOLUME 17-22-28 L
Height	520 mm WITH FRONT FILLING OR AUTOMATIC FILLING KIT
	670 mm WITH TOP FILLING (FILLING DOOR OPENING)
Width	550 mm
Depth	600 mm

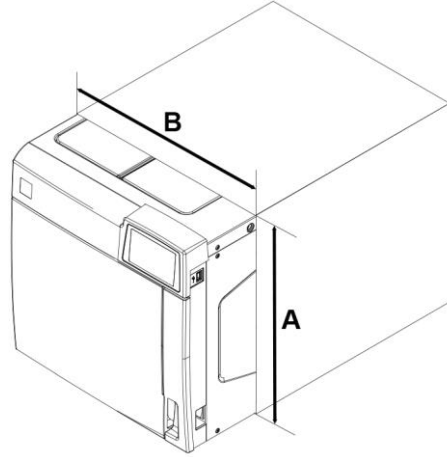

 **Compartment dimensions lower than those shown may compromise the correct circulation of air around the device and may not provide adequate cooling, with the consequent deterioration of performance and/or possible damage.**

 *If the main switch is inaccessible when installed in the compartment, use an electric plug that incorporates an on/off switch. Do not remove the upper cover nor any other external part. The device must be completely installed in the compartment. Please refer to appendix "technical characteristics" for complete technical data.*

4.3. GENERAL PRECAUTIONS FOR INSTALLATION

To ensure a correct operation of the device and/or avoid risk situations, respect the following **warnings**:

- Install the sterilizer on a flat and perfectly horizontal surface;
- Make sure that the support surface is strong enough to support the device weight (about 90 kg, complete with water in hydrostatic test configuration) **and has the following minimum dimensions: Width 550 mm, Depth 600 mm;**
- Leave adequate space for ventilation all around the sterilizer, in particular in the rear area;
- If the device is built-in into a cabinet, be sure to respect the warnings in the previous paragraph, avoiding any obstructions of the air intakes;
- Do not install the sterilizer too close to tubs, sinks or similar places, avoiding contact with water or liquids. This could cause short circuits and/or potentially dangerous situations for the operator;
- Do not install the sterilizer in excessively humid or poorly ventilated environments;
- Do not install the machine in environments with flammable and/or explosive gasses or vapours;
- Install the device so that the supply cable is not bended or squeezed.
- It must freely run all the way to the electrical outlet;
- Install the device so that any external filling/drainage pipes are not bent or squeezed.

4.4. POWER SUPPLY

The electrical system to which the sterilizer will be connected must be suitably dimensioned according to the electrical characteristics of the device. Plate data are shown in the TECHNICAL CHARACTERISTICS table and on the back of the machine.

4.5. ELECTRICAL CONNECTIONS

This information is shown on the **back of the machine**.

The sterilizer must be connected to a socket of the electric system having adequate capacity for the absorption of the device and properly earthed, in accordance with laws and/or regulations in force.

The socket must be properly protected through magneto-thermal and differential circuit breakers having the following characteristics:

- Rated current I_n **16 A**
- Residual current $I_{\Delta n}$ **0.03 A**

 **The manufacturer is not responsible for any damage caused by the installation of the sterilizer with unsuited and/or not properly earthed electric systems.**

 *Always connect the power cord directly to the power outlet.
Do not use extensions, adapters or other accessories.*

4.6. DIRECT CONNECTION TO A CENTRALIZED DRAINING POINT

- Remove the cap holding clip and the cap on the rear of the autoclave;
- Fit the plastic tube on the elbow union (supplied);
- Fit the union and then refit the clip;
- Fasten the clamp (supplied) to the drain siphon;
- Cut the tube to the right length and insert its free end into the centralized draining point union locking it with the dedicated ring nut.

 *Make sure that the tube is not bent, crushed or obstructed in any way.*

The following diagram provides an indicative arrangement of the components:

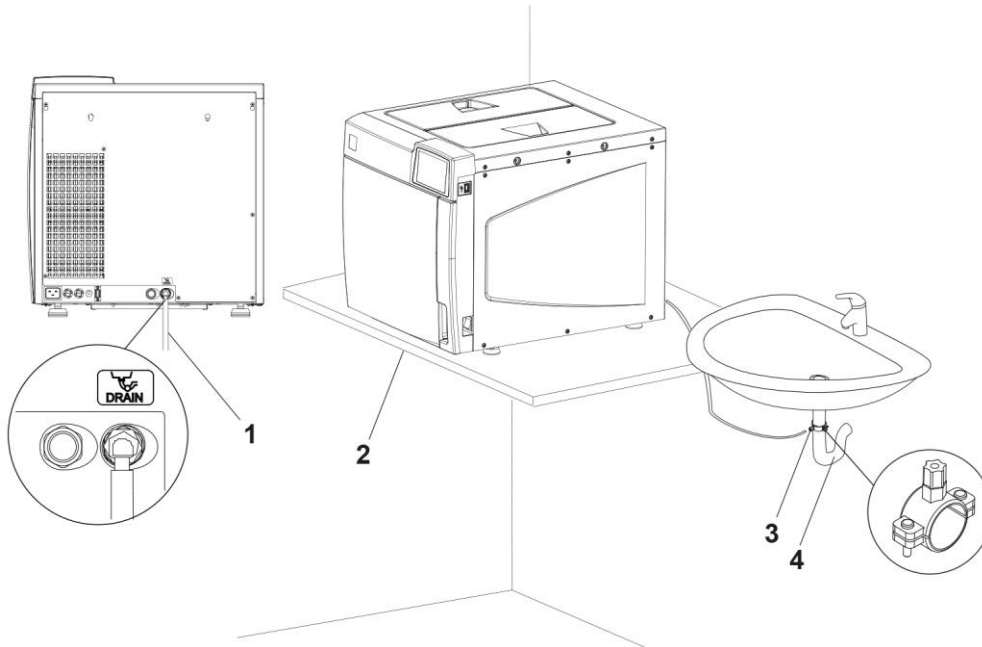

- | | |
|---|--|
| <p>1 At the centralized draining point;</p> <p>2 Resting surface;</p> | <p>3 Clamp;</p> <p>4 Drain siphon;</p> |
|---|--|

 *The position of the union of the centralized draining point must be lower than the resting surface of the sterilizer. Otherwise, the tank may not be emptied correctly.*

 *If an automatic filling system (external pump or solenoid valve, Pure 100, Pure 500) is connected the use of the direct drain connection is required.
In case of fault or failure, this system allows any excess water produced by the automatic filling system to flow into the centralized draining point, thus preventing flooding.*

5. FIRST START-UP

The time required to start the sterilizer is approximately 30 seconds.

5.1. STARTING

Once the sterilizer has correctly been installed, turn it on with the main switch on the right-hand side of the machine.

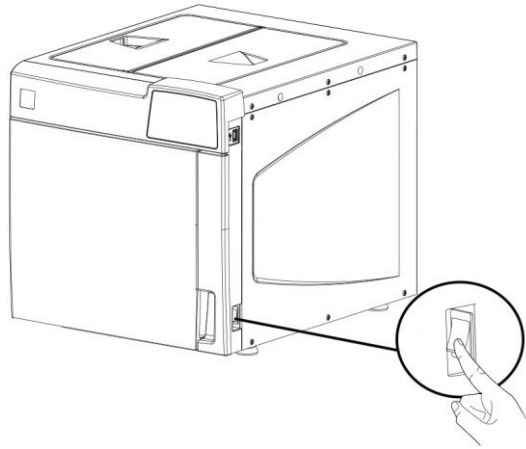

Do not turn on the sterilizer if USB key is inserted.

When the device is first turned on, the display shows the selection of LANGUAGE, DATE and TIME settings.

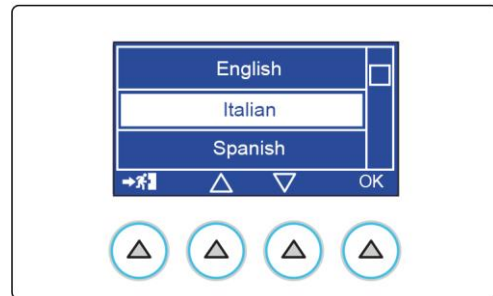

Once LANGUAGE, DATE and TIME have been set, the PREHEATING screen appears.

See section PREHEATING in chapter SETTINGS to set the relevant parameters.

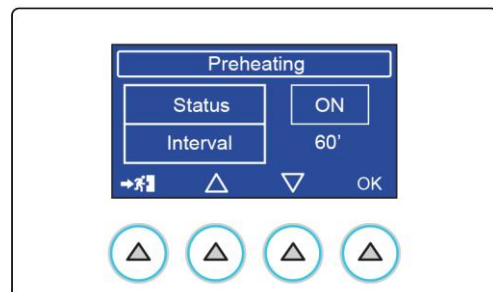
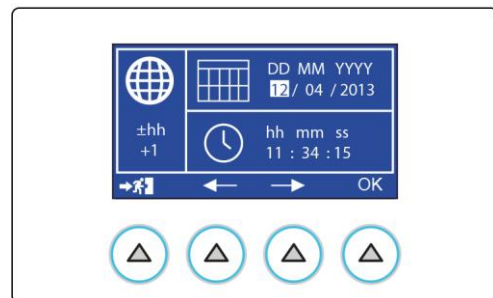

5.2. MAIN MENU

At the end of starting procedure the main menu is displayed on the side.

The sterilizer waits for the program selection (see "Program selection" Chapter).

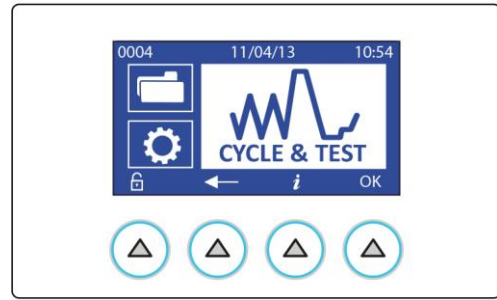

5.3. FILLING DISTILLED WATER

5.3.1. MANUAL FILLING

The first time the sterilizer is used, and later when the lack of water is signalled, you will have to fill, or top-up, the distilled water tank.

Open the filling door.

Pour in water taking care not to exceed the maximum level indicated inside the tank (MAX). Close the door.

Pay attention not to spill water on the machine; in case, promptly dry.

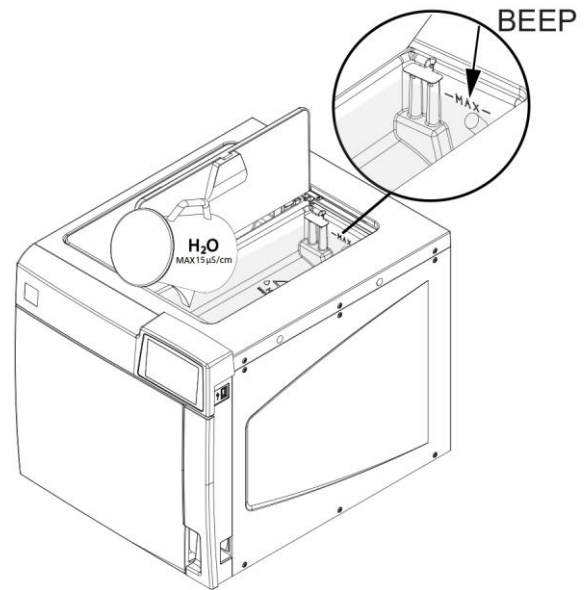

The tank must be filled before the cycle starts or after its completion. Do not open the tank doors during cycle execution in order to prevent water or hot steam leaks.

5.3.2. AUTOMATIC FILLING

Refer to appendix "ACCESSORIES" and to the Manual of the specific accessory.



If an automatic filling system (external pump or solenoid valve, Pure 100, Pure 500) is connected the use of the direct drain connection is required.

In case of fault or failure, this system allows any excess water produced by the automatic filling system to flow into the centralized draining point, thus preventing flooding.

6. CONFIGURATION

The sterilizers offer a wide range of customisable options. The user can thus configure the device according to his/her own needs, adapting the performance based on, for example, the type of activity carried out, the type of material to be sterilised and the frequency of use. Using the configuration program, the user can set a series of options available in user-friendly menus.

 Use the configuration program whenever necessary.
 A correct customisation of the device provides the best performance and the most satisfactory use.
 The technical service department (see appendix) is available to help users by providing suggestions or advices on the best way to use the options in the configuration program.

6.1. SETTINGS

To enter the configuration program, select the icon shown on the side and press OK.

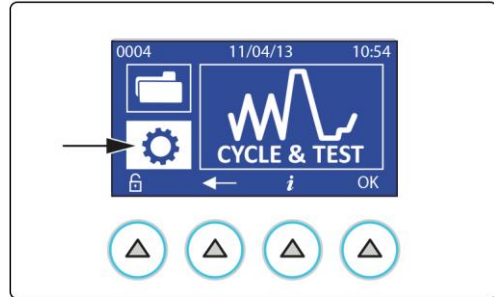

6.1.1. LANGUAGE

Select LANGUAGE option and confirm by pressing OK.

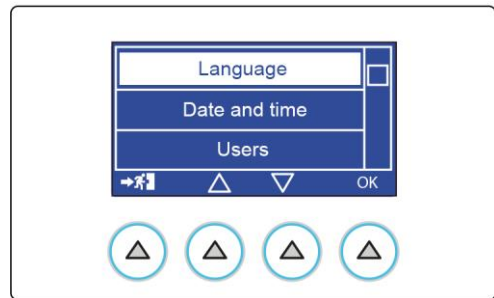

Select the desired language scrolling the list with arrows (▲ and ▼) and confirm by pressing OK.

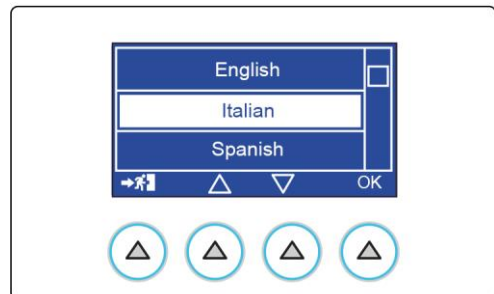

6.1.2. DATE AND TIME

Select DATE AND TIME option and confirm by pressing OK.

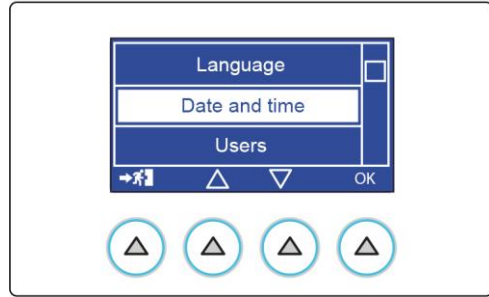

Select the field to be modified using the arrows and confirm using OK. Use + and - buttons to adjust the value. Confirm using OK and adjust the other fields. Press EXIT icon to save the selections and go back to the previous menu.

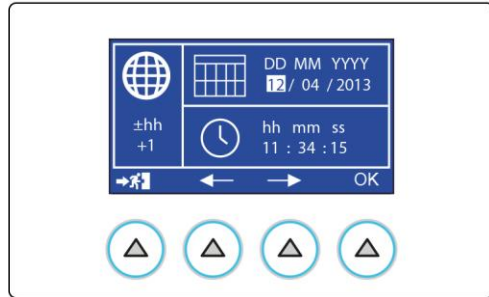

6.1.3. USERS

Not provided for S versions.

Enter the menu by selecting USERS and confirm with OK. Fill in the fields with user name and PIN, choosing a 4-digit numeric code.

The first user entered is given administrator rights.

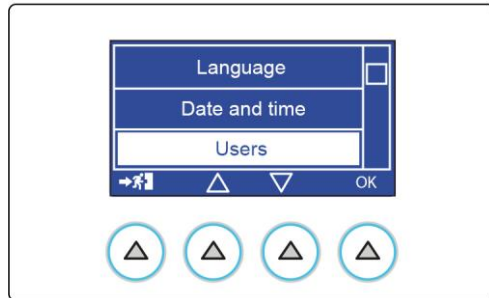

Enter the system administrator (Admin) PIN.

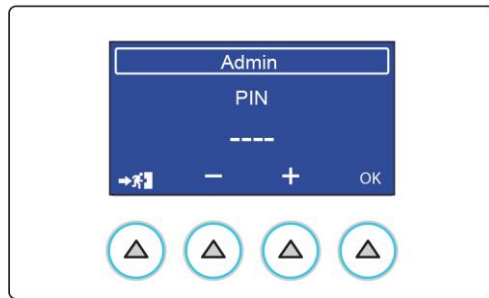

After you have entered the PIN, you can access the reserved administrator menu. To create a new user, select "Users list" in the list of options.

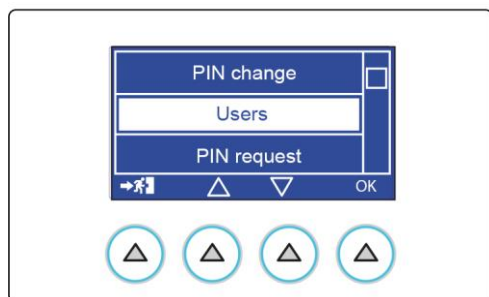

Select then "Create new user".

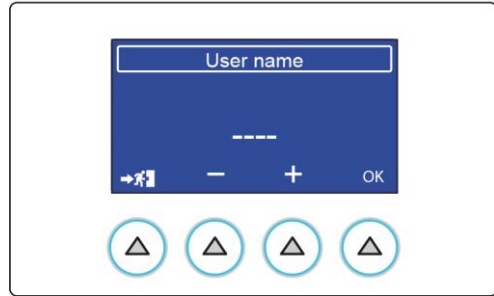
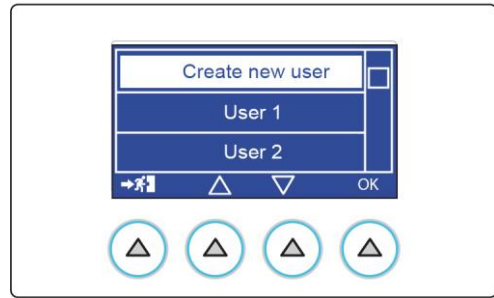

Use + and - to enter the identification "acronym" of the new user, inserting one letter at a time and confirming with OK until its completion. The first field activates when PIN is requested. Enter the value with + and - (digits from 0 to 9). Press OK to go to the next value, until the last one which confirms the PIN.

A maximum of 30 users can be entered.

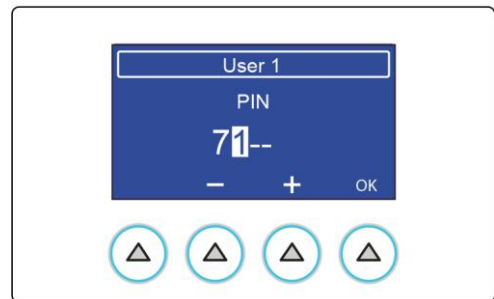
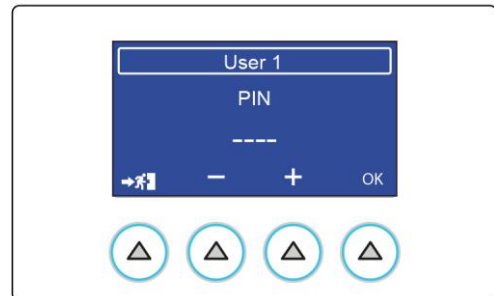

6.1.3.1. USER DATA

Select your own user from the list, if it already exists. Once entered, a NON ADMIN user can see only a summary of his/her data, or change his/her PIN (see entering PIN - the following is requested in sequence: current PIN, new PIN, new PIN confirmation).

The ADMINISTRATOR (ADMIN) user finds the following items:
 PIN change: he/she can change his/her PIN
 Users list
 PIN request
 User deletion

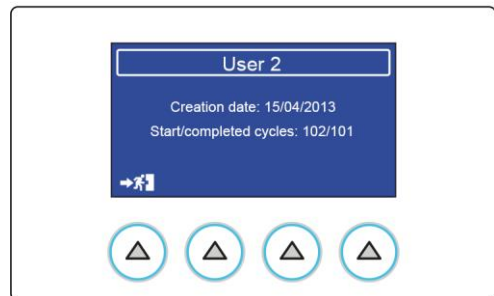

6.1.3.2. PIN CHANGE BY ADMINISTRATOR

Select the item indicated on the side and confirm with OK.

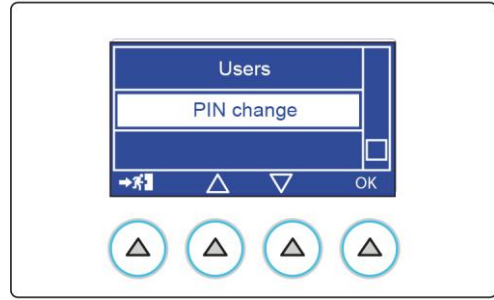

Enter the PIN currently used.

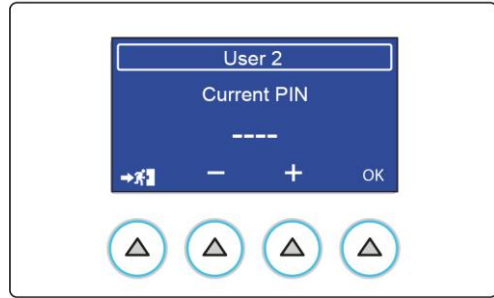

Then enter the new PIN.



If the user enters an incorrect pin for 3 times, at the following pin entering request it is necessary to enter the specific unlock pin (see APPENDIX - USER PIN RESET) indicated at the end of the manual.

The subsequent user menu access is like the first access.

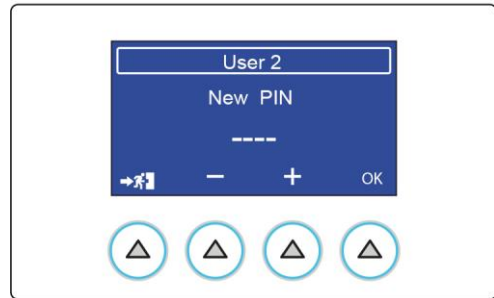

6.1.3.3. USERS LIST

Select the item indicated on the side and confirm with OK.

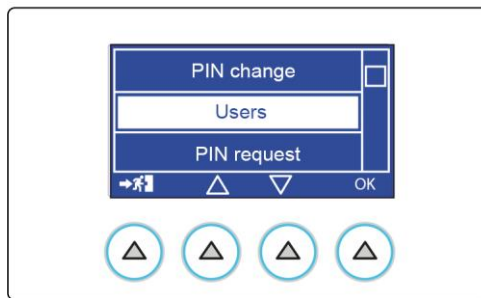

Select the desired user. Press OK to access the screen containing data of the selected user.

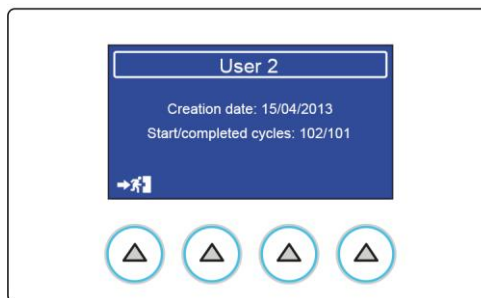
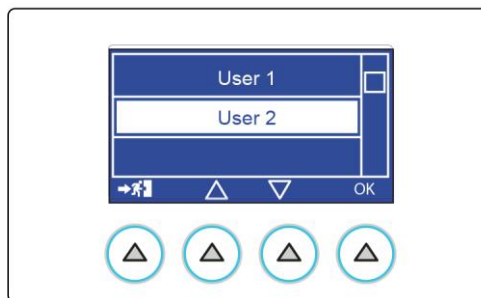

6.1.3.4. PIN REQUEST

Select the item indicated on the side and confirm with OK.

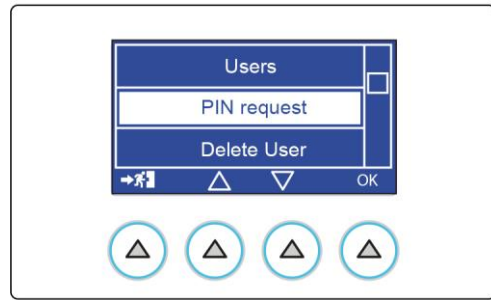

It is possible to activate either one of the two options or both.
 By activating "when cycle starts" the system requests the user to enter the PIN when the sterilization cycle starts.
 By activating "when cycle ends" the system requires to enter the PIN at the end of the cycle before unlocking the door.

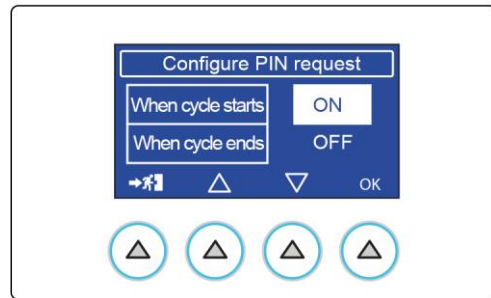
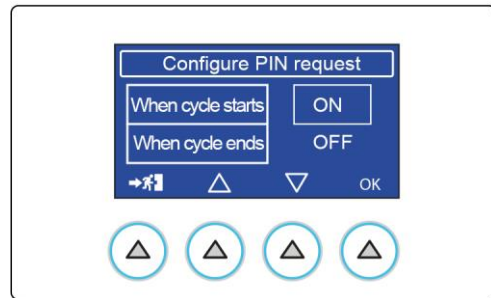

If PIN request is set at cycle start, press START to select the user and the relevant PIN.

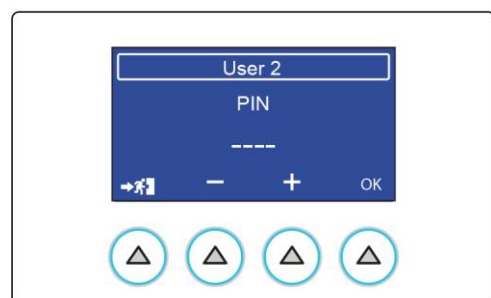
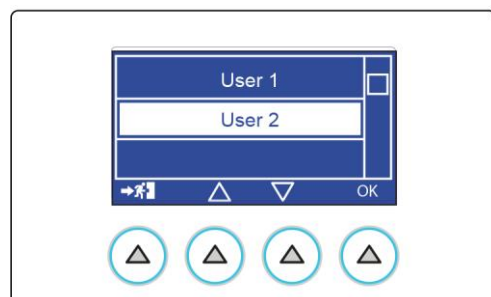
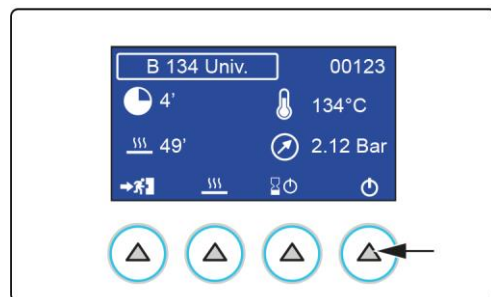

Once the PIN is confirmed, the cycle starts automatically.

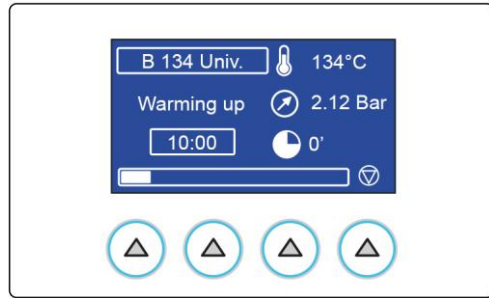

If PIN request is set at the end of the cycle, press the door unlocking button to display the summary screen of sterilization cycle parameters.

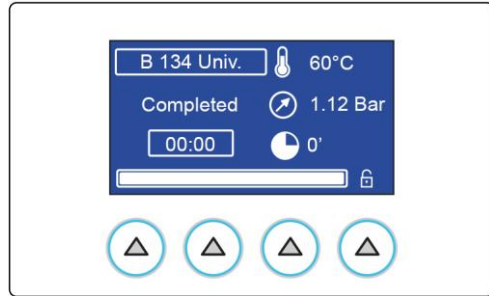

By pressing OK the user confirms the positive cycle result and authorises the assignment of the sterilized material. User and relevant PIN selection is required.

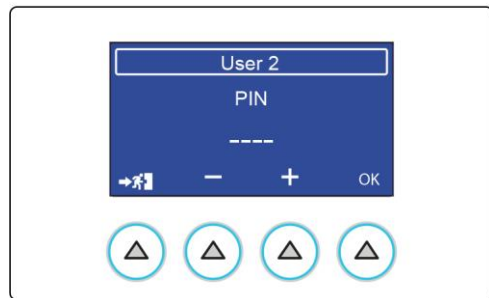
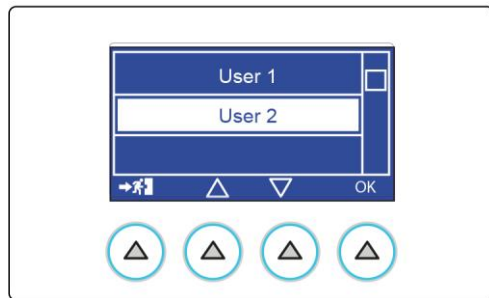

Once PIN is confirmed the autoclave door opens and the load can be collected.

6.1.3.5. DELETE USERS

The ADMIN user can delete one or more users.

Select the item in the list, press OK to enter the users list. Select the user to be deleted and press OK to confirm or  to exit the screen.

Confirm deletion by pressing OK.

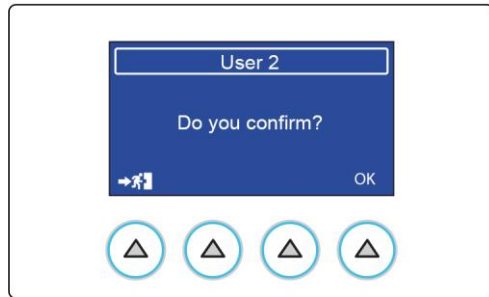
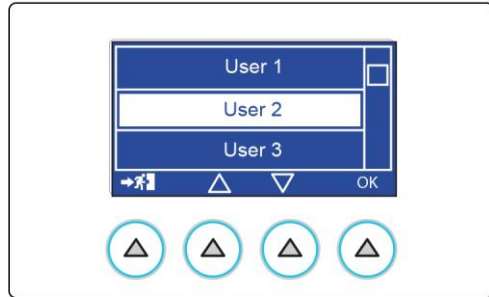
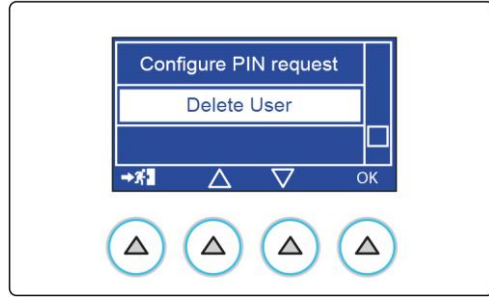

6.1.4. PREHEATING

Select the PREHEATING option and confirm by pressing OK.

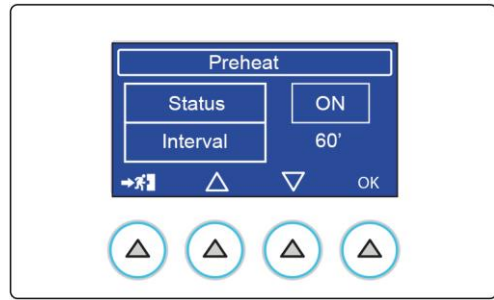

Select ON to activate PREHEATING.
Confirm by pressing OK.

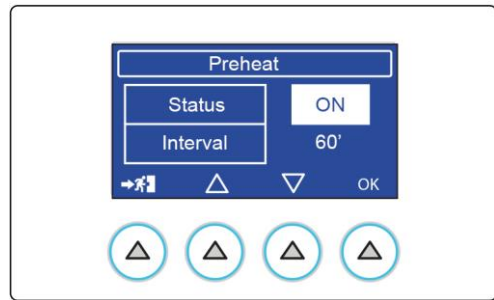

When the PREHEATING is active, the INTERVAL control allows setting the maximum operating time, after which the warming up is disabled. A value of 30 to 120 minutes can be set.

Preheating is only activated when the first (sterilization or test) cycle is complete, or if the cycle fails and only if it is not a vacuum test. This allows to run a vacuum test as first cycle when the device is turned on and repeat it if it does not succeed.

Interval minutes should be set according to the number of cycles that are planned in one day. The set time approximately corresponds to the pause between one cycle and the other. In this way, the device stays warm and heating time is reduced.

6.1.5. WATER FILLING





Select WATER FILLING option and confirm by pressing OK.

Available options include:

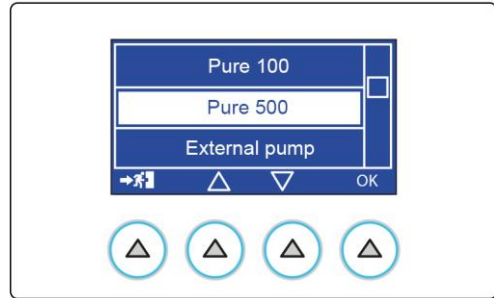
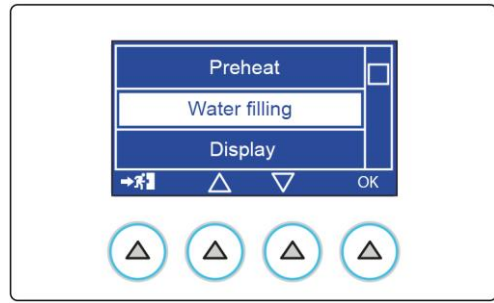
- Pure 100
- Pure 500
- External pump
- Aux Ev kit
- Manual filling
- Automatic filling

Select the desired option according to the accessory connected and confirm with OK.



-  *In S models, Pure 100 and Pure 500 are disabled.*
-  *Not provided for S versions.*
-  *When connecting the automatic filling system, the sterilizer asks you to identify the type of device actually connected by pressing the corresponding button.*
-  *If connecting the filling system when the sterilizer is off, access the menu via the configuration program and manually select the correct option.*
-  *This menu can also be used to temporarily deactivate the automatic filling system (filters exhausted, fault, etc.) and go to manual tank filling, keeping the automatic filling system connected.*

Select "Manual filing" and confirm with OK.

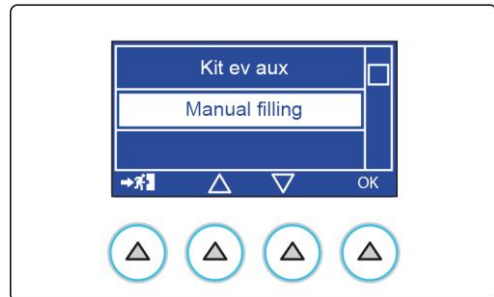

6.1.6. DISPLAY

Select DISPLAY option to adjust brightness and contrast of the screen, confirm by pressing OK.
 Select the field to be modified using the arrows and confirm using OK.
 Use + and - buttons to adjust the value.
 Confirm using OK and adjust the other fields.

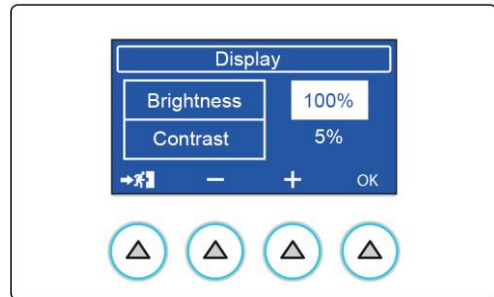
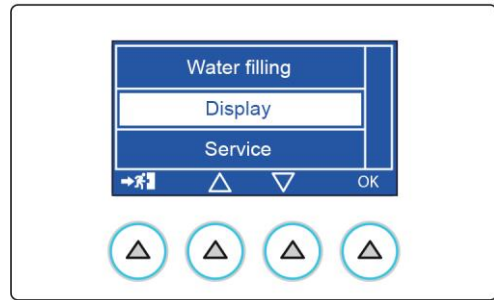

6.1.7. TEST REMINDER

Select the TEST REMINDER option if you want a message to be displayed when a specific test must be carried out, confirm by pressing OK.
 Select how often the test will be performed and confirm by pressing OK.

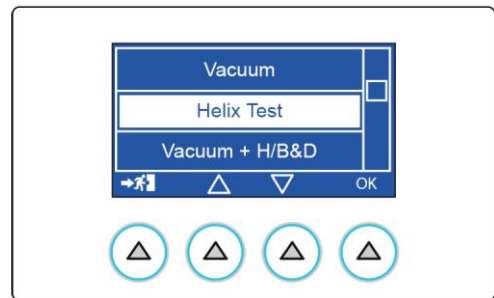

When the TEST REMINDER option is set, a pop-up will remind the user to run the test according to the chosen frequency.

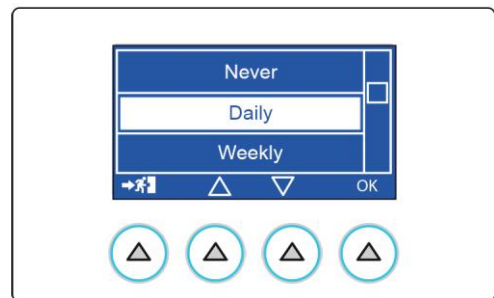

6.1.8. SERVICE

This menu is intended for the technical service department.
 It can be used only by an authorised technician.

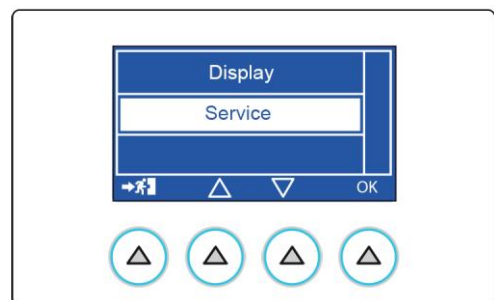

7. PREPARATION OF THE MATERIAL



Always use personal protective equipment.



First of all, it should be recalled that, when handling and managing contaminated material, it is a good idea to take the following precautions:

- Wear rubber gloves of suitable thickness and the specific protective mask on your face;
- Clean your gloved hands with a germicide detergent;
- Always carry the instruments on a tray;
- Never carry them in your hands;
- Protect your hands from contact with any sharp points or edges; this will avoid the risk of contracting a dangerous infection;
- Immediately remove any article that does not need to be sterilized or that is not capable of withstanding the process;
- Carefully wash your still gloved hands when done handling non-sterile material;
- All materials and/or instruments to be sterilized must be perfectly clean, without any type of residue (deposits of organic/inorganic material, fragments of paper, cotton/gauze pads, lime, etc.).

 *In addition to causing problems during sterilization, the failure to clean and remove residue can damage the instruments and/or sterilizer itself.*

7.1. TREATING THE MATERIAL BEFORE STERILIZATION

An effective cleaning consists of the following:

- 1 Separate metal instruments by type of material (carbon steel, stainless steel, brass, aluminium, chromium, etc.), to avoid electrolytic oxidation-reduction.
- 2 Clean the instrument with an ultrasound device containing a mixture of water and germicide solution carefully following the manufacturer's recommendations, or use a heat disinfectant.
For best results, use a detergent specifically designed for ultrasound washing.
- 3 Manual washing is necessary if no dedicated devices are available or when automatic washing is not permitted due to the technical features of the treated material. This technique exposes the operators in charge to higher risks, for this reason it must only be applied when it is strictly necessary.

 *Solutions containing phenols or quaternary ammonia compounds can cause corrosion on instruments and on the metal parts of the ultrasound device.*

- 4 After washing, carefully rinse the instruments and make sure that residues have been completely eliminated; if necessary, repeat the washing cycle.
- 5 Dry all treated instruments. Drying is fundamental because the presence of water traces on the surface can jeopardise the following sterilization process.
The following items can be used for drying:
 - Paper, non-woven fabric or low-particle wipes;
 - Compressed air to dry hollow instruments.

The operator must wear suitable PPE and protect the working surface to prevent its contamination by any air-dispersed particles.

 *To avoid the formation of lime spots, rinse with deionized or distilled water, if possible.
Whenever very hard tap water is used, we recommend always drying the instruments.*

For handpieces (turbines, contra angles, etc.), in addition to the procedure described above, perform a cleaning treatment on the special devices ensuring a proper internal cleaning (sometimes including lubrication).

 *At the end of the sterilization program, remember to lubricate the internal handpiece mechanisms. By taking this precaution, the instrument life time will not be reduced in any way.*

 **Consult the instructions provided by the manufacturer on the instrument/material to be sterilized before subjecting it to autoclave treatment, checking for any incompatibilities.
Strictly follow instructions for use of detergents or disinfectants and instructions for use of automatic devices for washing and/or lubrication.**

As regards textile materials (porous), such as lab coats, napkins, caps and other, carefully wash and dry them before treating them in the autoclave.

 *Do not use detergents with a high content of chlorine and/or phosphates. Do not bleach with chlorine-based products. These substances can damage the tray supports, trays and any metal instruments that may be present in the sterilization chamber.*

7.2. ARRANGING THE LOAD



Always use personal protective equipment.



To get the best effectiveness of the sterilization process and preserve the material over time, increasing its useful life, follow the instructions below.

General notes for the positioning on trays:

- Arrange instruments made of different metals (stainless steel, hardened steel, aluminium, etc.) on different trays or anyway on trays well separated from one another.
- In case of instruments not made of stainless steel, put a sterilization paper napkin or a muslin cloth between instrument and tray, avoiding direct contact between the two different materials;
- In any case, arrange the objects sufficiently spaced from each other, so that they can remain in such position for the whole sterilization cycle;
- Make sure that all instruments are sterilized in an open position;
- Position cutting instruments, (scissors, scalpels, etc.) so they can not come into contact with each other during sterilization; if necessary, use a cotton cloth or a gauze to isolate and protect them;
- Arrange recipients (glasses, cups, test tubes, etc.) resting on their side, or upended, thus avoiding pooling water;
- Do not load trays beyond the limit indicated (see Appendix).
- Do not stack trays one on top of the other and do not put them in direct contact with the walls of the sterilization chamber.
- Always use the supplied tray support.
- To insert and remove trays from the sterilization chamber, always use the special supplied extractor.



 Place one sterilization chemical indicator per tray to indicate when the process is complete: this will allow avoiding an unnecessary repetition of the process on the same load or, worse, the use of unsterilised material. If packed material is sterilized, place the indicator inside one of the packages.

Note for rubber and plastic hoses:

- Always rinse before use with pyrogen-free water; do not dry;
- Arrange hoses on tray so that their ends are not obstructed or squashed;
- Do not bend or twist hoses, but leave them as linearly stretched as possible.

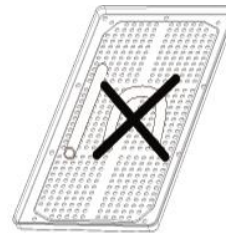

Notes for packages:

- Arrange packages next to each other, duly spaced and not stacked, avoiding their contact with chamber walls;
- Should it be necessary to wrap special objects, always use a suitable porous material (sterilization paper, muslin napkins, etc.), closing the package with adhesive tape suitable for autoclave.

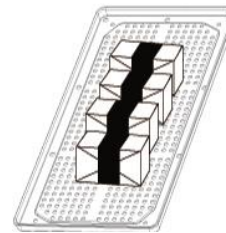

Notes for packed material:

- Individually pack the instruments or, in case several instruments are placed inside the same bag, make sure they are made of the same metal;
- Seal the case with a thermosealer or adhesive tape for autoclaves;
- Do not use metal staples, needles or the like, as sterility could be affected;
- Lay the bags so as to avoid the creation of air pockets, which could potentially prevent steam correct penetration and removal;
- Position bags in such a way to leave the paper side up and the plastic side down (tray side);
- In any case, make sure that this position proves effective, reverting it, if necessary;
- If possible, using a suitable support, position bags at right angles with tray;
- Never stack bags one on top of the other.

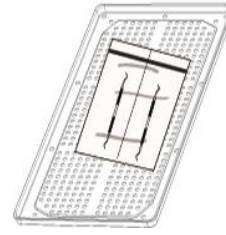

**Always pack instruments if they have to be stored for a long time.
Refer also to the indications given in chapter “sterilized material storage”.**

Program selection is an essential operation for the correct performance of the sterilization process.

Since all instruments, or material in general, have a different structure, consistency and properties, the **most suitable program must be identified**, both to preserve the physical characteristics (avoiding or, in any case, limiting its alterations) and to ensure the best effectiveness of the sterilization process.

A guide for the selection of the correct program based on the load is present **inside Programs Appendix**.

7.3. POSITIONING AND USE OF TRAY HOLDER SUPPORT

Tray holder support can be used in "tray" version (5/6 compartments based on the sterilizer model).



Or, if tray holder support is extracted and turned by 90°, it can be used to house special "boxes" (3/4 compartments based on sterilizer model).



In any case, it is possible to position the boxes (3 or 4 depending on the sterilizer model) vertically.

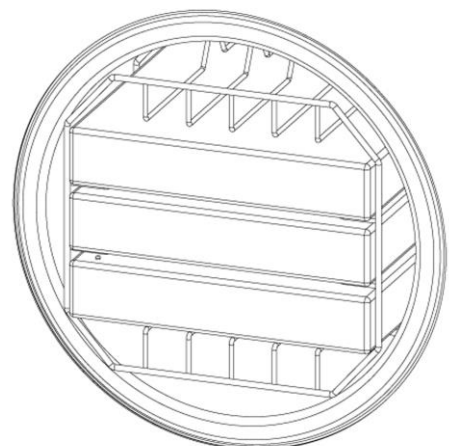
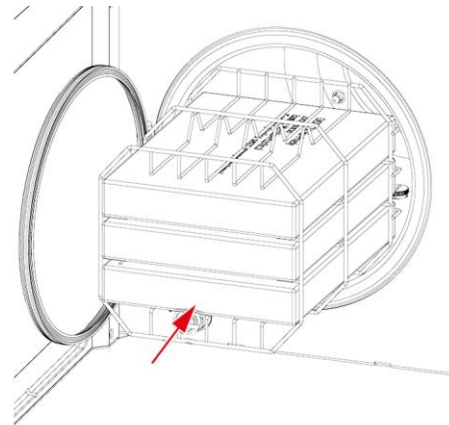
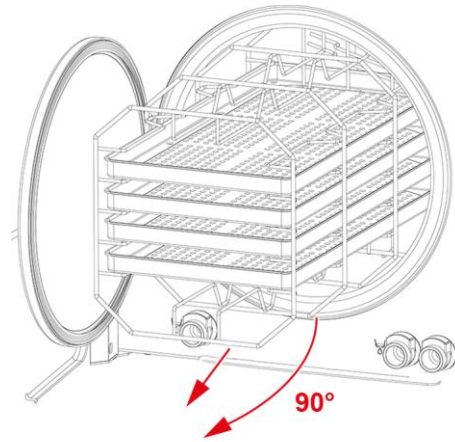

8. STERILIZATION CYCLES

A sterilization cycle consists of a determined number of phases.

The number and duration of the phases can differ for the different cycles, based on the type of air extraction, sterilization process and drying methods.

Available cycles are:

- 134° Universal B
- 121° Universal B
- 134° Prion S
- 134° Solid S
- 134° Veloce S
- User-defined

For S type versions:

- 134° Solid (Wrap.) S
- 121° Solid (Wrap.) S
- 134° Prion S
- 134° Solid N
- 121° Solid N
- User-defined

The electronic control system monitors the various phases, at the same time checking that the various parameters are respected; if any type of anomaly is encountered during the cycle, the program is immediately interrupted, generating an alarm identified by a code, with a relative message explaining the nature of the problem.

With this type of control, when you select a suitable sterilization program, you are guaranteed an effective sterilization under any conditions.

After inserting the load in the sterilization chamber (taking the precautions described in the section “**Preparing the material to be sterilized**”), select the desired sterilization cycle as follows:

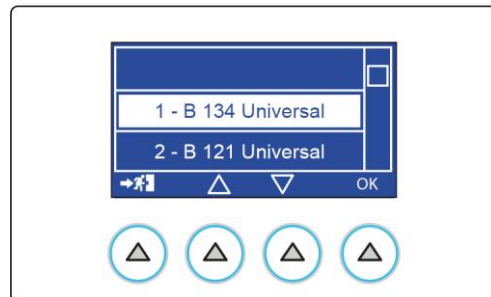
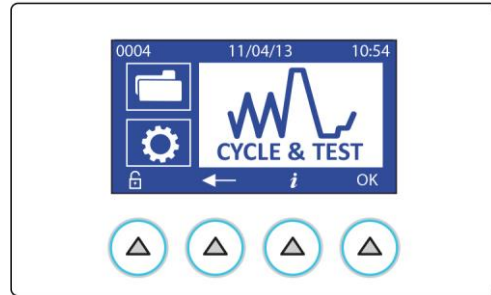

8.1. EXTRA DRYING

Select EXTRA DRYING option by pressing the indicated button

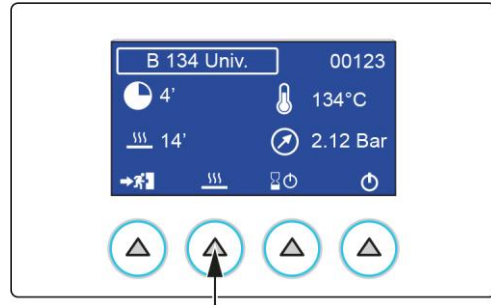

Use + and - buttons to set the additional drying time and confirm.

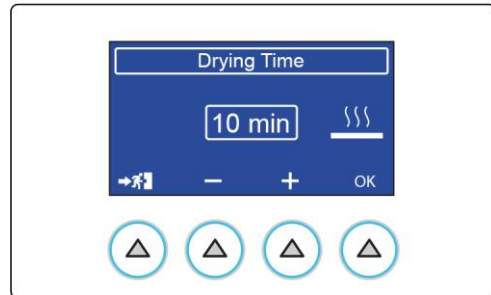
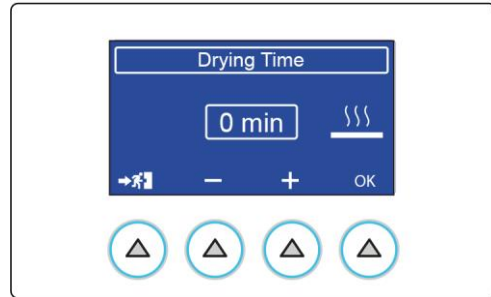

After the confirmation, the extra drying value appears near the total cycle time.

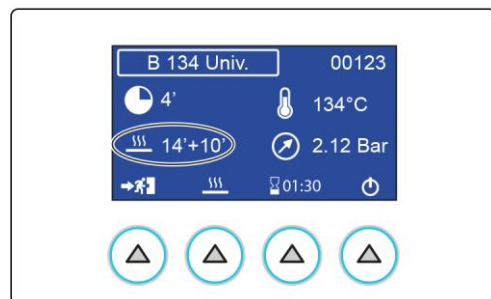

The additional value remains saved.

8.2. DELAY START

Select DELAY START option by pressing the indicated button.

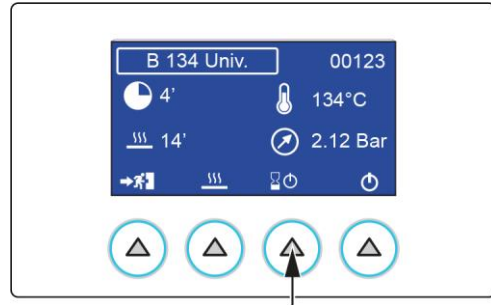

Use + and - buttons to set the additional start delay and confirm.

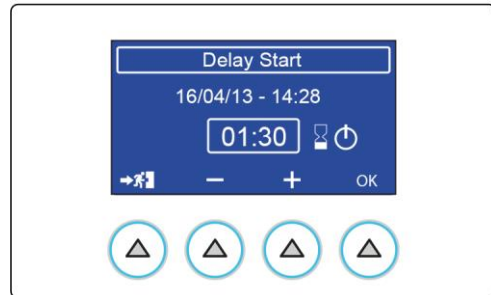
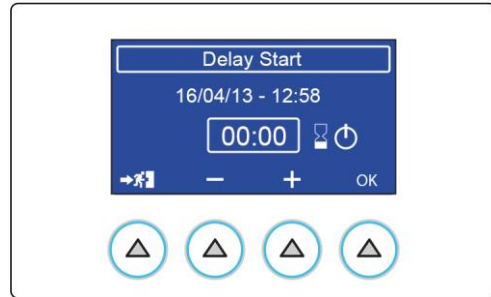

After confirmation the set time appears on the display.

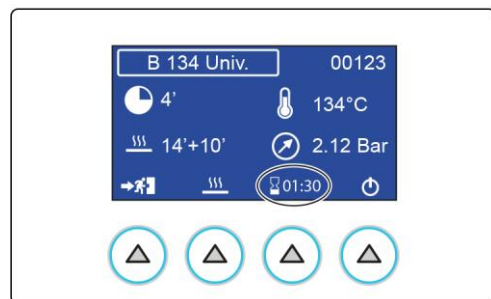

8.3. EXECUTION OF THE CYCLE

Press START to start the cycle with selected active options.

Taking as example the most complete and significant sterilization cycle, i.e. the **134°C UNIVERSAL B** program, characterised by fractionated pre-vacuum, the cycle sequence is as follows:

- WARMING UP
- FIRST VACUUM PHASE
- FIRST PRESSURE RISE
- SECOND VACUUM PHASE
- SECOND PRESSURE RISE
- THIRD VACUUM PHASE
- THIRD PRESSURE RISE
- STERILIZATION
- STEAM DISCHARGE
- DRYING
- VENTILATION
- CYCLE COMPLETION

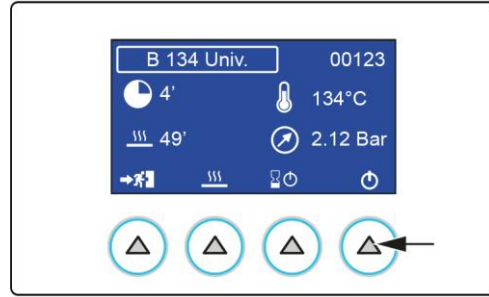

8.4. CYCLE OUTCOME

At the end of the cycle it is important to check the sterilization process outcome.

If the message "**COMPLETED**" is displayed, it means that the cycle has been completed correctly without any interruptions for alarms and that **complete asepsis** of the material is guaranteed.

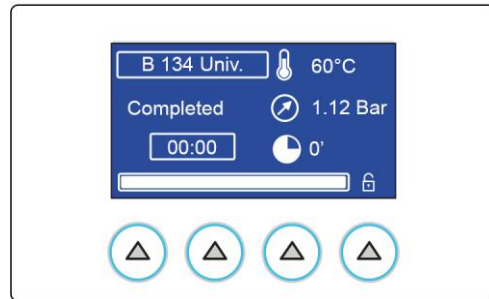

8.5. DOOR OPENING AT THE END OF THE CYCLE

To open the sterilizer door, press the button shown in the figure:

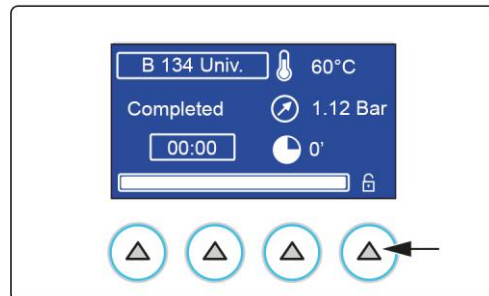



8.6. USER-DEFINED CYCLE

To set parameters select the following item and confirm.

The display shows:

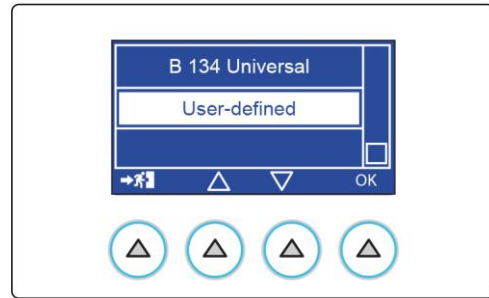
- 1 At first start-up, the data of 134 Universal cycle;
- 2 From the second time on, the last settings.



Select button 

The arrows allow moving across the 4 adjustable values:

- Vacuum: single or fractionated;
- Temperature: 121°C/134°C;
- Process time: Minimum time expected for the temperature set, it can be increased up to a maximum of 30' (in 1' steps);
- Drying time: Standard drying time for the temperature set, it can be increased up to a maximum of 30'.

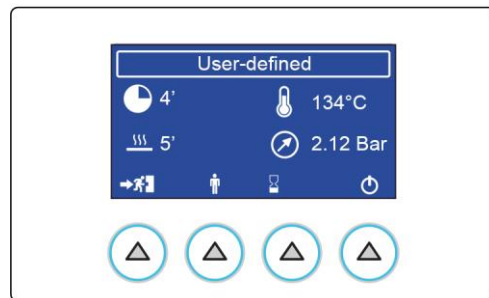

Use + and - buttons to adjust the value. Confirm using OK and adjust the other fields.

Once you have made the selections, using the exit button, save settings and go back to the previous screen.

Press to start the user-defined cycle.

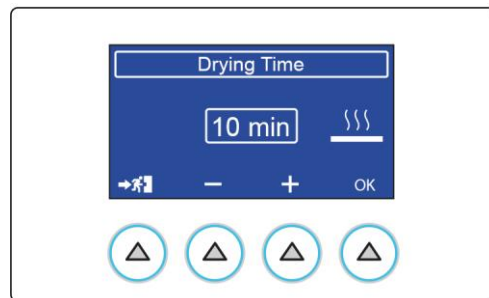

9. MATERIAL STORAGE

The sterilized material must be adequately treated and stored to maintain its sterility over time, until its use.

Inadequate storage **can** cause **rapid recontamination**.

This leads to problems regardless of what you do since you will either be using recontaminated material (most of the time unconsciously), placing the user and patient at risk, or you will have to run the sterilization cycle again, with an inevitable waste of time and resources.

For this reason, we think it will be useful to provide several basic suggestions, leaving the operator the task of further study of specific texts.

Assuming that the sterilizer is located in a clean place, free of dust and not too damp, the following **precautions** should be taken when handling and/or carrying sterile material:

- 1 Remove the load from the sterilization chamber wearing gloves and a clean, or even better, sterilized smock. As an additional precaution, wear a protective mask on your face;
- 2 Rest the trays on a dry, suitably clean and disinfected surface. Take care to distance or, at any rate, separate the sterile material from the area where contaminated material is kept waiting to be sterilized;
- 3 Touch the material and/or instruments as little as possible, taking extreme care not to cut or damage the wrappings;

Let the instruments cool before any transport (and subsequent storage). If necessary for transport, transfer the material using dry, clean and disinfected containers.

The containers must be closed or, if open, covered with clean cloths.

Before use, sterile material must be stored using the appropriate techniques.

These will significantly **slow** recontamination:

- 1 Store the material and/or instruments in the protective wrappings that were used during sterilization. Do not wrap the instruments after sterilization since, in addition to being useless and completely senseless, is also potentially harmful;
- 2 Store the material in a dry, suitably clean and disinfected place, far from the area where infected material passes. If possible, use closed compartments equipped with ultraviolet light;
- 3 Identify the sterile material by attaching the sterilization date (enclosing a copy of the printed report or an adhesive label);
- 4 First use the material that has been stored the longest (FIFO, "First In First Out"). This results in material that is homogeneously stored, avoiding storing it for too long, with the consequent risks.
- 5 Never store material for too long. In fact, do not overlook the fact that materials will tend to degrade and be recontaminated in a finite time, even when the above instructions are followed.

 Consult the specifications provided by the manufacturer of the packaging material relative to the maximum allowed storage time.

 Such storage times may vary from country to country, according to the local legal requirements.

10. TEST PROGRAMS

To protect the safety of users and patients, a fundamental process like sterilizing medical devices should be periodically checked.

The device offers the possibility of easily and automatically executing two distinct test cycles:

- **HELIX TEST/B&D (not provided for S versions);**
- **VACUUM TEST;**
- A program that executes the two tests combined **VACUUM + B/D (not provided for S versions)** is also available;
- There is also a further test to check the water quality: **H2O Test (not provided for S versions).**

10.1. HELIX TEST/B-D CYCLE

Not provided for S versions.

HELIX TEST / B&D is a cycle run at 134°C characterised by a sterilization phase that lasts a specific time (3.5 minutes); the cycle comprises the fractionated vacuum phases similar to those used in the UNIVERSAL cycles.

Using an appropriate device, you can assess correct steam penetration into hollow loads (Helix Test).

The cycle is also suitable to measure steam penetration into porous loads (**Bowie & Dick** test pack).

To select the **Helix Test/B&D** cycle, select **Helix Test/B&D** using the arrows and confirm with OK.

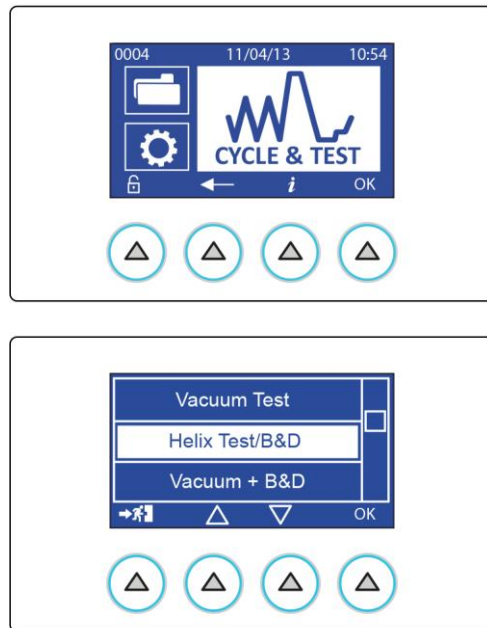

The HELIX test device (in accordance with EN 867-5 specifications) consists of a 1.5 m-long PTFE tube, with an inside diameter of 2 mm to whose end a small hermetically-sealed screw cap is fastened, able to contain an appropriate chemical indicator.

The other end of the tube is left free so that the steam can penetrate and you can assess its effectiveness.

To conduct the test (with reference to standard EN 13060), insert the chemical indicator, consisting of a paper strip with a special reagent ink in the device cap (always to be used perfectly dry). Tighten the cap in such a way that seepage through the gasket is not possible.

The test device and the chemical indicators to execute the helix/b&d test cycle are not provided with the device. For information in this regard, contact technical service department (see appendix).

Place the device roughly in the middle of the central tray. Do not insert other material in the chamber. Close the door and start the cycle.

The test cycle takes place with a succession of phases similar to those described for a normal sterilization cycle.

At the end of the cycle, remove the test device from the chamber, open the cap and remove the indicator from its housing.

If the steam has correctly penetrated, the ink will have completely changed its original colour over the entire length of the strip; if not (insufficient penetration), there will only be a partial colour change or even no change at all.

Toning usually occurs from a light colour (beige, yellow, etc.) to a dark colour (blue, violet or black). In any event, strictly follow the instructions and any additional technical details provided by the indicator manufacturer.

10.2. VACUUM TEST CYCLE

The VACUUM TEST cycle allows testing perfect seal of the sterilizer hydraulic system. Measuring the variation of the degree of vacuum in a defined time-frame and comparing it with pre-established limit values, you can determine how good the seal of the sterilization chamber, tubes and the various interception devices is.

To select the VACUUM TEST cycle, select VACUUM TEST using the arrows and confirm with OK.

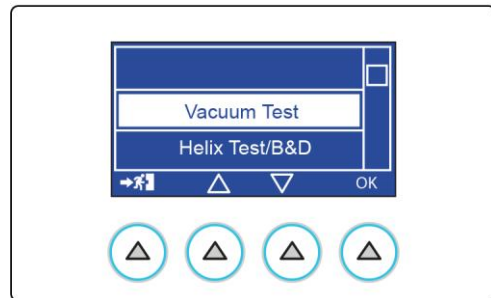
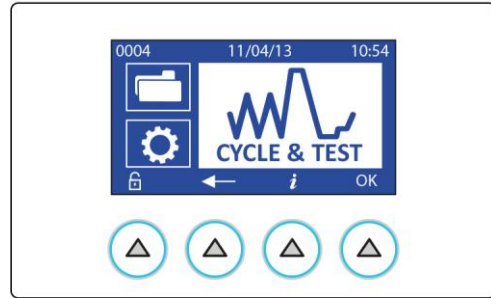

The cycle must be run with the sterilization chamber empty, and only the trays and their supports inserted.

We suggest to run this test at the beginning of each working day with chamber at ambient temperature.

A high chamber temperature affects the variation in the vacuum value measured during the test; the system is therefore programmed to prevent execution of the test when the operating conditions are inadequate.

Close the door and start the program.

The vacuum phase starts immediately and the pressure value (bar) and the countdown from the start of the test cycle are shown on the display.

If the pressure variation exceeds the limit defined, the program is interrupted and an alarm message generated.
For the complete description of the alarms refer to appendix.

10.3. VACUUM + B-D TEST CYCLE

| *Not provided for S versions.*

Select this option to run a VACUUM TEST cycle and a HELIX TEST/B&D cycle in sequence.

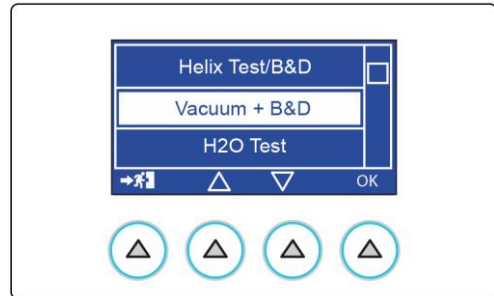
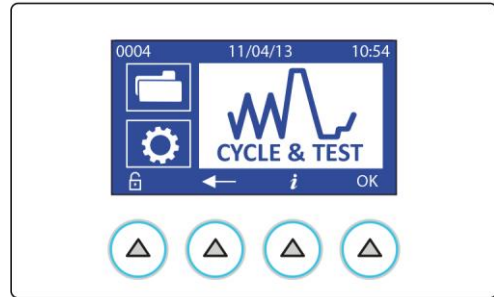

To this end, place the test device on the central tray without inserting other material. Close the door and start the cycle. The program will execute the two cycles in succession. Check the results as described in the previous paragraphs.

| *The presence of the device does not alter the execution and the result of the vacuum test cycle.*

10.4. H2O TEST

| *Not provided for S versions.*

Select this option to test the water quality.

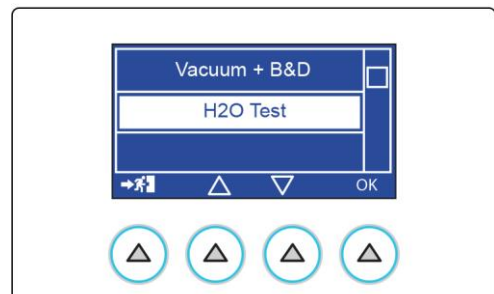
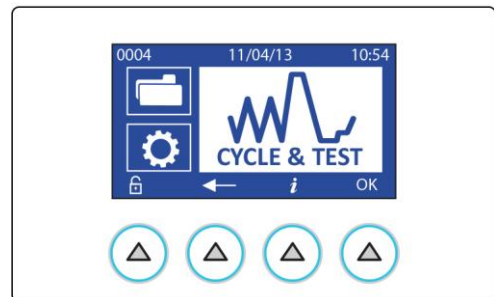

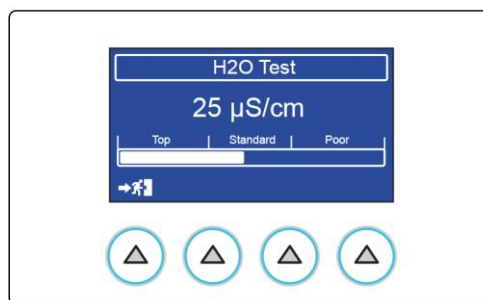

 | *The water conductivity is automatically measured at each sterilization or test cycle start.*

10.5. DOOR OPENING

To open the autoclave door, press and hold the button shown in the figure.

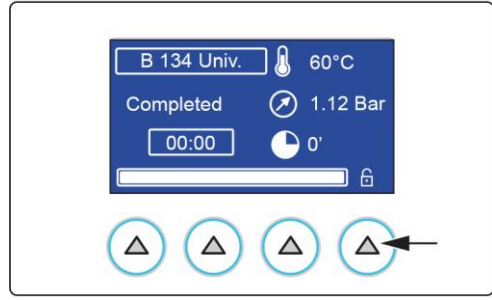

The door opens and stays ajar.

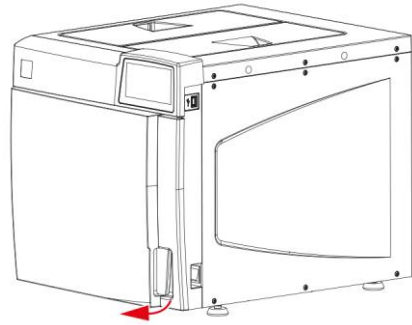

Now you can manually open the door.

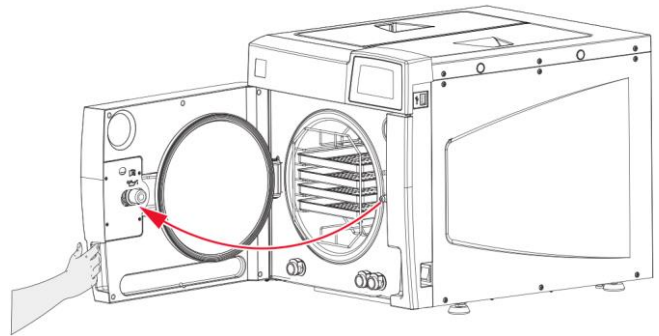

10.6. MANUAL INTERRUPTION

The cycle can be interrupted by the operator in any moment, **by holding down the key indicated in the figure for about three seconds.**

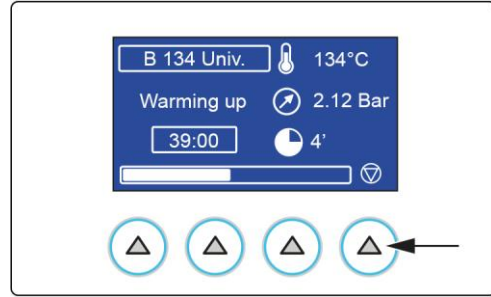

The command generates **E999 error** since the cycle could not finish correctly.

 *If the cycle is interrupted during certain phases, an automatic cleaning procedure of the internal hydraulic circuit starts. For the complete description of the alarms refer to "alarms" appendix.*

Press and hold RESET for about three seconds to open the door.

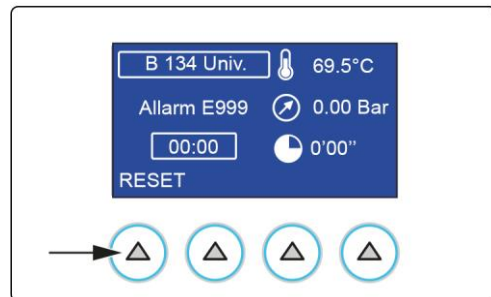

After a manual interruption of the program, the load must not be used since the sterilization is not ensured.

11. USED WATER DRAIN

When the water maximum level is reached, a specific message is displayed.

Open the door and continue as follows:

- 1 Prepare a basin with a capacity of at least 4 litres in proximity to the sterilizer; place the free end of the drain tube provided in the basin;
- 2 Insert the other end of the tube in the female union beneath the chamber inlet (connector on the left) pushing down until you hear a click;
- 3 Completely empty out the tank and then press on the upper part of the union and detach the tube quick coupling.



Do not open the tank doors during the cycle execution in order to prevent hot water leaks or spurts.

Detaching the tube

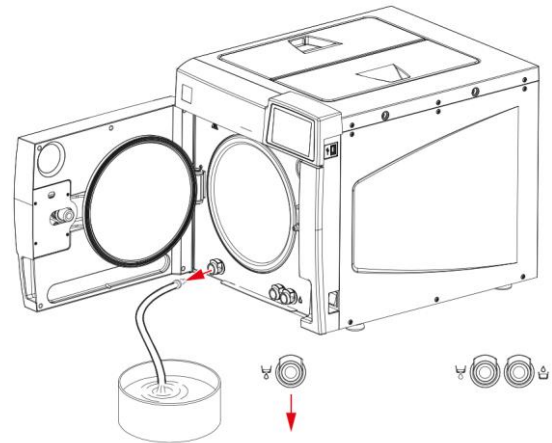
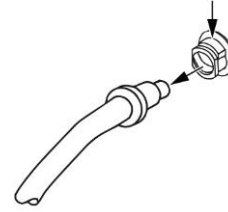

12. DATA MANAGEMENT

To enter the DATA MANAGEMENT section, select the following icon and press OK button.

This section allows you to set the following parameters:

- Print management;
- Downl. cycle data;
- Wi-Fi;
- Ethernet.

By selecting SYSTEM INFORMATION all the information about the sterilizer settings are displayed.

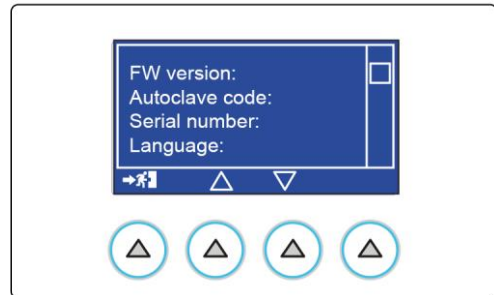
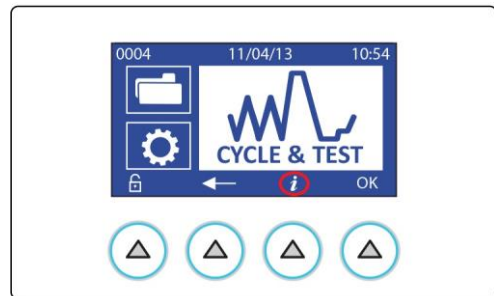
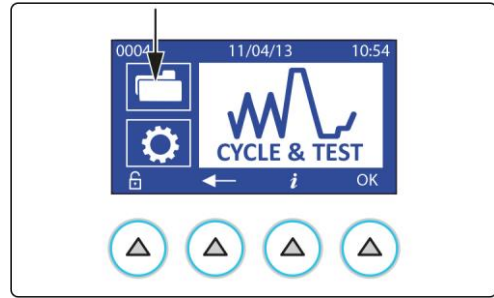

12.1. PRINT MANAGEMENT

To set parameters select the following item and confirm with OK.

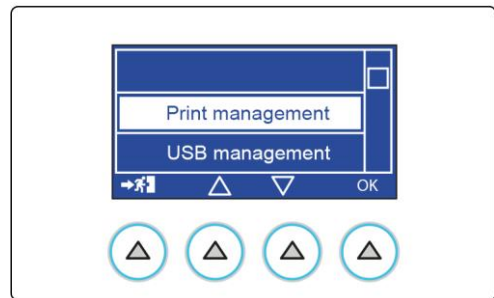

Select PAPER SETTINGS to choose the support between:

- Do not print;
- Report;
- Extended report;
- Barcode Labels.

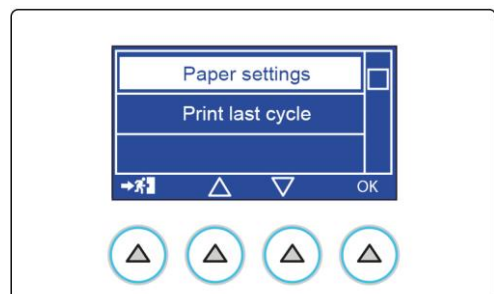

12.2. PRINT LABELS

At the end of the cycle, when pressing the button indicated, the following page is displayed only if the printer is connected to the sterilizer and set for label printing (settable from print management).

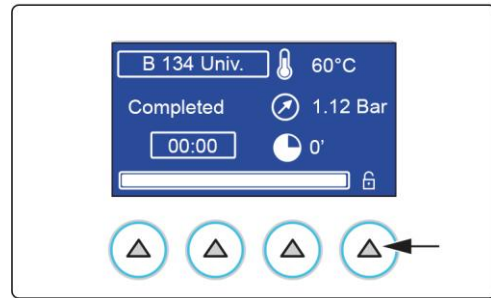

Select the field to be set using the arrows (number of labels to be printed at the end of the cycle and material expiration), confirm using OK.

Use + and - buttons to adjust the value.

Confirm using OK and adjust the other fields.

Once you have made the selections, using the exit button, save settings and go back to the previous screen.

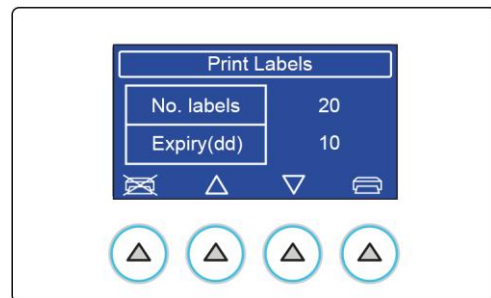

If the printer is connected to the autoclave and REPORT option is set, the sterilizer automatically prints the summary report at the end of the cycle.

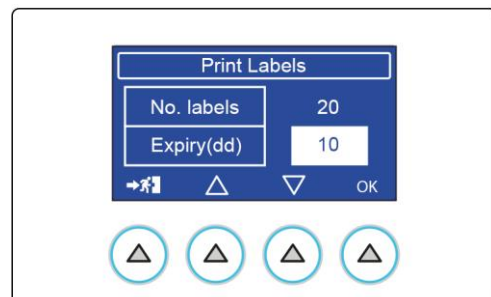
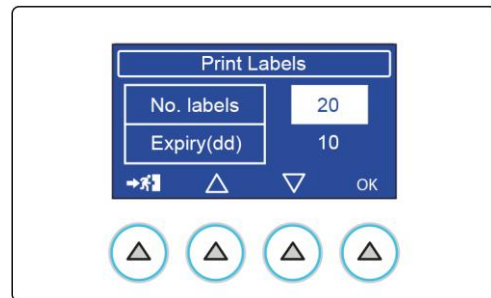

With REPORT option set, select PRINT LAST CYCLE to print the summary report of the last cycle.

With LABELS option set, the PRINT LABELS screen will be displayed.

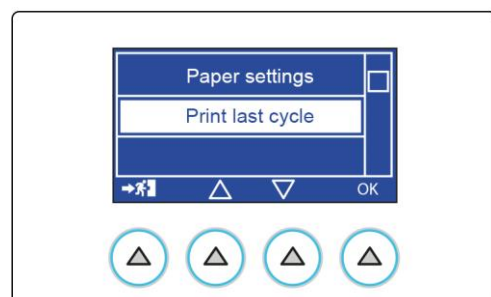

12.3. DOWN. CYCLE DATA

By selecting DOWNL. CYCLE DATA, it is possible to copy data about the cycles carried out, stored in the inner memory of the sterilizer, on a USB key.

 *The USB key must be formatted according to the instructions set forth in: appendix - technical characteristics, summary table.*

It is possible to select the number of cycles to download on the external storage device.

Select NEW to download cycle / test reports periodically.

If the USB stick is not present, its insertion is required.

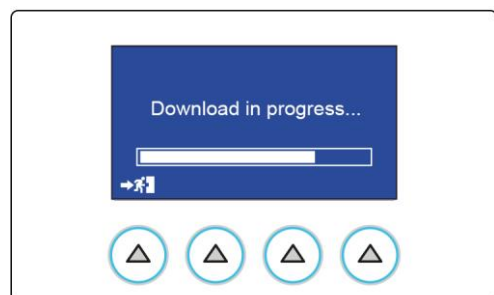
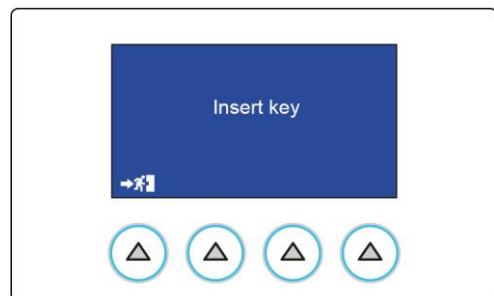
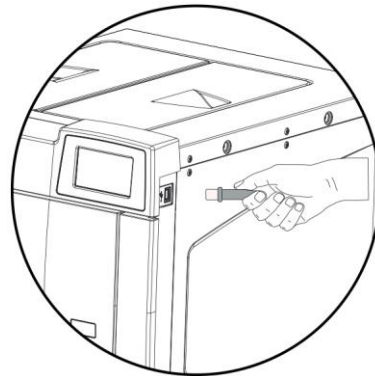
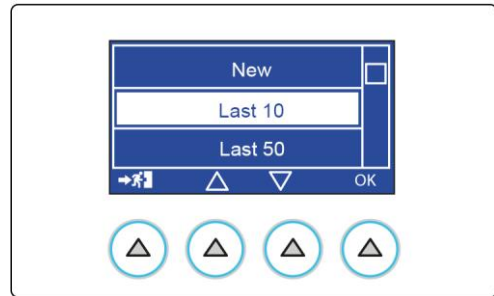
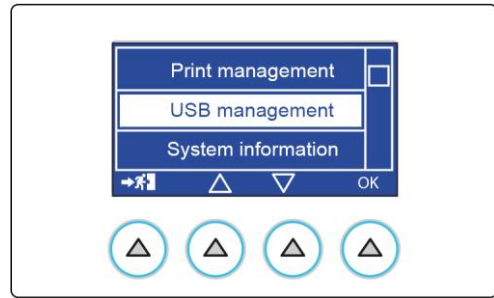

The sterilization test / cycle report files are downloaded in PDF format.

At the end of the download it is possible to remove the stick.



Do not turn on the sterilizer if USB key is inserted.

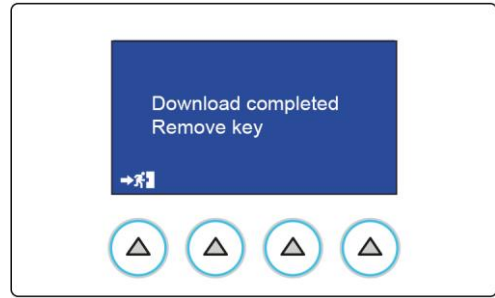

12.4. WIFI

Select Wi-Fi to connect the sterilizer to a local Wi-Fi network.

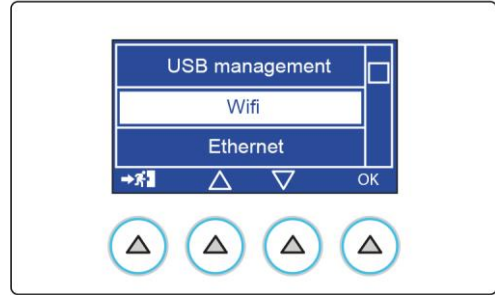

The following items are available when accessing Wi-Fi:

- Networks search;
- Manual entry;
- Settings;
- On/Off.

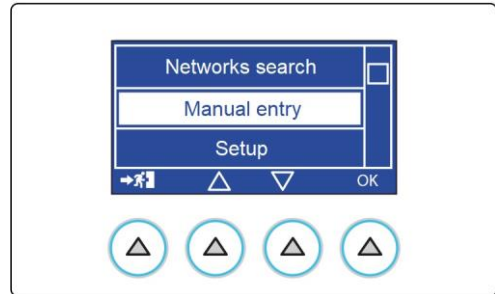

Select ON/OFF to enable or disable Wi-Fi connection.

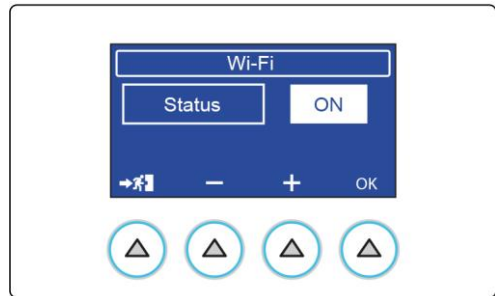

Choose Networks Search to select a network, from the list automatically shown, to which the device is to be connected.

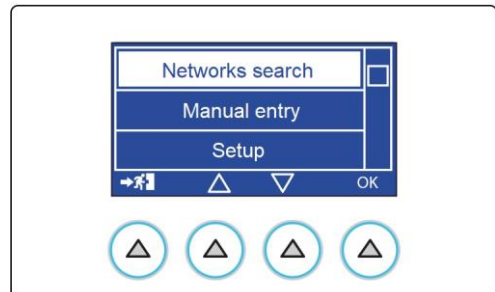

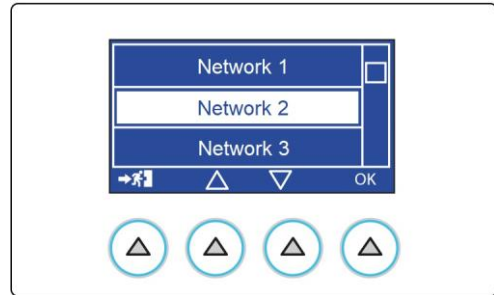
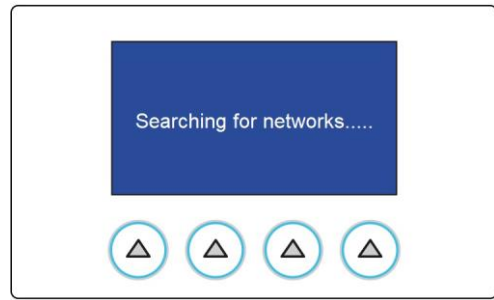

After selecting the network, enter the login password.
It is possible to delete an entered password with the Reset Password command.

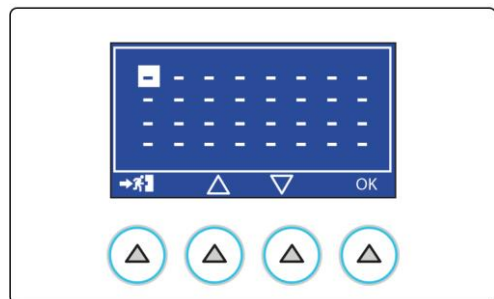

The MANUAL entry of the network allows manual typing of SSID and PASSWORD (PSW) of the desired network.

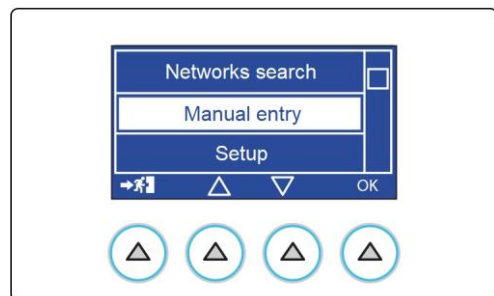

After entering the network (SSID) name, enter the login password.
It is possible to delete the network (SSID) name or the password entered using Reset SSID and Reset Password commands.

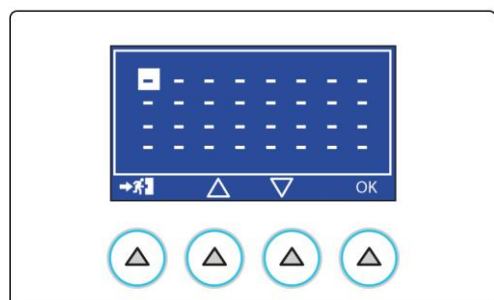
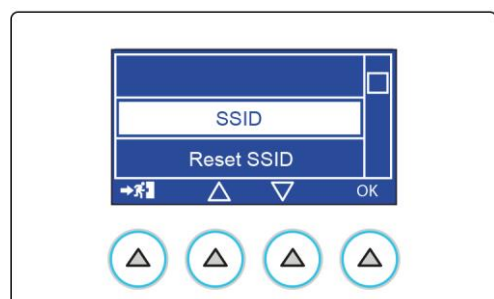

Select SETUP to access a manual entry menu for all network data.

DHCP can be set as automatic or manual.

In automatic mode the network configuration parameters are assigned automatically, in manual mode the network configuration parameters must be set manually.

After the selection, confirm with OK.

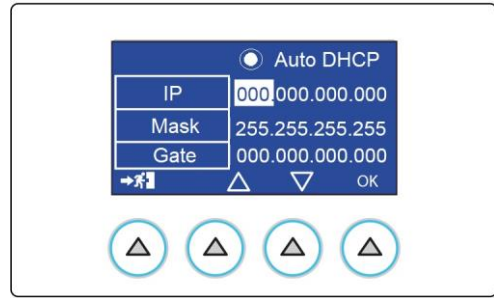

Make sure that Automatic DHCP configuration is selected.

With this selection all the numeric fields present on the screen are disabled.

With this setting at each start the sterilizer requests the network DHCP server its configuration using the DHCP protocol.

According to DHCP server configuration the numbering received may change at each start.

The TCP-IP number assigned to the sterilizer appears in the Ethernet or Wi-Fi setting screen.

It is usually possible to set DHCP server in order to always assign the same IP number to a given device or to assign the same number to a given device for a predetermined period of time.

For these settings refer to the instruction manuals of your DHCP Server or of the local network Internet router.

These settings require the "MAC address" of the sterilizer; please contact the technical service.

12.5. ETHERNET

Select ETHERNET to connect the sterilizer to a local Ethernet network.

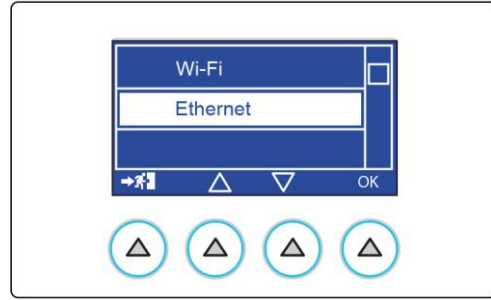

DHCP can be set as automatic or manual. In automatic mode the network configuration parameters are assigned automatically, in manual mode the network configuration parameters must be set manually.

After the selection, press ENTER.

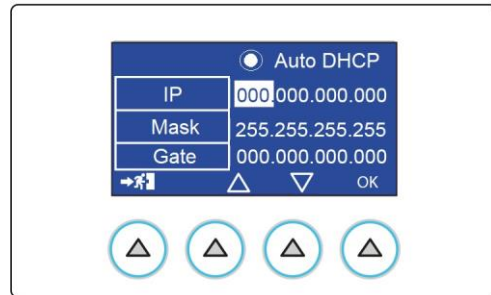

Make sure that Automatic DHCP configuration is selected. With this selection all the numeric fields present on the screen are disabled. With this setting at each start the sterilizer requests the network DHCP server its configuration using the DHCP protocol. According to DHCP server configuration the numbering received may change at each start. The TCP-IP number assigned to the sterilizer appears in the Ethernet or Wi-Fi setting screen. It is usually possible to set DHCP server in order to always assign the same IP number to a given device or to assign the same number to a given device for a predetermined period of time. For these settings refer to the instruction manuals of your DHCP Server or of the local network Internet router. These settings require the "MAC address" of the sterilizer, please contact the technical service.

12.5.1. CONNECTION TO A LOCAL NETWORK EQUIPPED WITH DHCP SERVER, WITH STERILISER CONFIGURED WITH STATIC IP

In order to avoid checking often the TCP-IP number assigned dynamically from a DHCP Server, it is possible to assign manually a fixed number of the dynamic numbering of the local network.

To avoid conflicts it is essential to:

- Configure DHCP Server so that it does not assign the selected number to other devices.

Or:

- Assign statically a number out of the range assigned by the DHCP server to the sterilizer.

For the information needed for a correct configuration check DHCP server settings of the local network.

To assign statically an IP address to the sterilizer:

- Access 'Data management' menu;
- Display the Ethernet configuration page;
- Make sure that Automatic DHCP configuration is selected.

With this selection all the numeric fields on the screen are disabled.

Take the first three numbers of the local network numbering, in the example above the first three numbers are: 10.20.8.xxx.

 As an alternative, in Windows systems it is possible to use IPCONFIG command from a 'Command prompt' window (accessible from programs -> accessories) to detect the local network configuration.

Now it is necessary to set statically the new number as follows:

- 1 Select manual configuration;
- 2 Set the first three fields of the address with the values detected (e.g.: 10.20.8);
- 3 Assign the chosen number to the last value, e.g. 222 (out of the range assigned automatically, avoiding 0 and 255);
- 4 Check that Subnet Mask field is set to 255.255.255.0;
- 5 Gateway address is not important for communications inside the network (set 0.0.0.0).

Then the complete IP address (in this example) is: 10.20.8.222.

12.5.2. CONNECTION TO A LOCAL NETWORK MANUALLY CONFIGURED WITH "STATIC" IPs

If the local network is configured in static mode, you need to assign the IP number as follows:

- Display the Ethernet configuration page;
- Make sure that manual configuration is selected.

Normally, static networks (like many small or domestic networks) have a range of addresses selected from so-called "masked" networks, for example, 192.168.0.xxx or 192.168.1.xxx.

For correct configuration, all you need to do is assign a number belonging to the local network (first three values) and the last number must not be used by another device).

In Windows systems it is possible to use IPCONFIG command from a 'Command prompt' window (accessible from programs -> accessories) to detect the local network numbering.

To check the numbers already assigned to a local network, there are programs that scan the devices present in the network (IP scan).

The sterilizer proposes its default IP Address, i.e. 192.168.1.100.

Adapt the static address of the sterilizer to your network.

In any event, you need to correctly assign the number 255.255.255.0 to the Subnet mask; the Gateway address is not important for communications inside the network (set 0.0.0.0).

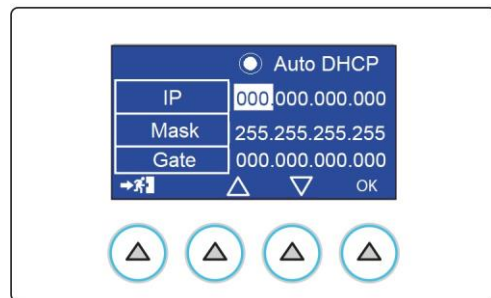
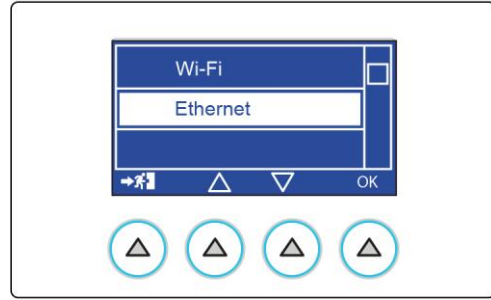

For the PC to be able to connect, it should have a configuration similar to that shown below (the example refers to Windows 7):

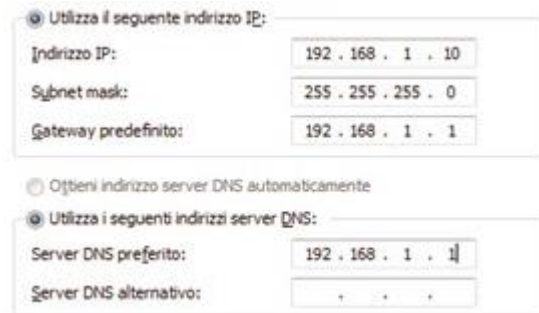

The configuration panel can be accessed via Properties of the network card.

13. APPENDIX – PROGRAMS

Water steam sterilization is suitable for almost all the materials and instruments, provided that they can bear without damage a **minimum temperature of 121°C** (if this is not the case, other low-temperature sterilization systems must be used).

The following material can normally be sterilized with water steam:

- Stainless steel surgical/generic instruments;
- Carbon steel surgical/generic instruments;
- Rotating and/or vibrating instruments driven by compressed air (turbines) or mechanical transmission (contra angles, tooth scalers);
- Glass items;
- Mineral-based items;
- Heat-resistant plastic items;
- Heat-resistant rubber items;
- Heat-resistant textiles;
- Medication materials (gauze, pads, etc.);
- Other generic material suitable for autoclave treatment.

 Depending on the material conformation (solid, hollow or porous), on any package containing it (paper/plastic bag, paper for sterilization, container, muslin napkins, etc.) and on its resistance to heat, it is essential to choose the suitable sterilization program, referring to the table in the next page.



The device must not be used for the sterilization of fluids, liquids or pharmaceutical products.

 **"Prion" cycle**
 The reference standard for this device, EN 13060, does not lay down any requirements for inactivation processes that cause spongiform encephalopathies as scrapie, bovine spongiform encephalopathy and creutzfeldt-jakob disease.
 The cycle named "prion" (18 min at 134°C) applies national regulations, which indicate this modified steam sterilization process as part of a prion decontamination program.

13.1. SUMMARY TABLE OF S 17 220 V - 240 V CYCLES

CYCLE DESCRIPTION	NOMINAL VALUES				BASIC CYCLE PARAMETERS					STERILIZABLE MATERIALS			NOTES	
	Temperature (°C)	Pressure (bar)	Retention time (min)	Cycle type (EN 13060:2014)	Pre-vacuum (F=fractionated; S=single)	Standard drying (min)	Total cycle time (max filling)	Max H2O consumption (ml/cycle)	Average energy consumption (kWh/cycle)	TYPE	MAX TOTAL MASS (kg)	MAX MASS PER TRAY (kg)		MAX MASS PER ITEM (kg)
S 134°C PRION	134	2.1	18	S	S	20	54	550	0.9	Solid and hollow instruments "B" in single pack	3.00	1.00	0.25	For wrapped materials and instruments (single and double pack), it is advisable to use the 3-tray configuration
S 121°C SOLID	121	1.1	20	S	S	20	55	550	0.8	Solid and hollow instruments "B" in single pack	3.00	1.00	0.25	
S 134°C SOLID	134	2.1	4(*)	S	S	20	40	300	0.6	Solid and hollow instruments "B" in single pack	3.00	1.00	0.25	It is advisable to use the 3-tray configuration
										Unwrapped solid and hollow instruments "B"	6.00	1.20	0.50	
N 134°C SOLID	134	2.1	4(*)	N	S	10	32	300	0.5	Unwrapped solid and hollow instruments "B"	6.00	1.20	0.50	
N 121°C SOLID	134	2.1	4(*)	N	S	10	47	350	0.5	Unwrapped solid and hollow instruments "B"	6.00	1.20	0.50	
XXX°C USER (see note)	134-121	2.1-1.1	4÷30 - 20÷30	n.a.	F/S	5÷30	n.a.	n.a.	n.a.	Unwrapped solid instruments (other load types are possible depending on the user settings)	n.a.	n.a.	n.a.	Variable parameters depending on the settings made
VACUUM TEST	-	-0.75	-	-	-	-	23	-	-	Empty chamber	-	-	-	

13.2. SUMMARY TABLE OF S 22 220 V - 240 V CYCLES

CYCLE DESCRIPTION	NOMINAL VALUES				BASIC CYCLE PARAMETERS					STERILIZABLE MATERIALS			NOTES	
	Temperature (°C)	Pressure (bar)	Retention time (min)	Cycle type (EN 13060:2014)	Pre-vacuum (F=fractionated; S=single)	Standard drying (min)	Total cycle time (max filling)	Max H2O consumption (ml/cycle)	Average energy consumption (kWh/cycle)	TYPE	MAX TOTAL MASS (kg)	MAX MASS PER TRAY (kg)		MAX MASS PER ITEM (kg)
S 134°C PRION	134	2.1	18	S	S	14	56	600	0.9	Solid and hollow instruments "B" in single pack	4.00	1.00	0.25	For wrapped materials and instruments (single and double pack), it is advisable to use the 3-tray configuration
S 121°C SOLID	121	1.1	20	S	S	14	57	600	0.8	Solid and hollow instruments "B" in single pack	4.00	1.00	0.25	
S 134°C SOLID	134	2.1	4(*)	S	S	14	42	350	0.6	Solid and hollow instruments "B" in single pack	4.00	1.00	0.25	It is advisable to use the 3-tray configuration
										Unwrapped solid and hollow instruments "B"	7.50	1.20	0.50	
N 134°C SOLID	134	2.1	4(*)	N	S	7	33	350	0.5	Unwrapped solid and hollow instruments "B"	7.50	1.20	0.50	
N 121°C SOLID	134	2.1	4(*)	N	S	7	48	350	0.5	Unwrapped solid and hollow instruments "B"	7.50	1.20	0.50	
XXX°C USER (see note)	134-121	2.1-1.1	4÷30 - 20÷30	n.a.	F/S	5÷30	n.a.	n.a.	n.a.	Unwrapped solid instruments (other load types are possible depending on the user settings)	n.a.	n.a.	n.a.	Variable parameters depending on the settings made
VACUUM TEST	-	-0.75	-	-	-	-	23	-	-	Empty chamber	-	-	-	

13.3. SUMMARY TABLE OF 17 220 V - 240 V CYCLES

CYCLE DESCRIPTION	NOMINAL VALUES				BASIC CYCLE PARAMETERS						STERILIZABLE MATERIALS				NOTES
	Temperature (°C)	Pressure (bar)	Retention time (min)	Cycle type (EN 13060:2014)	Pre-vacuum (F=fractionated; S=single)	Standard drying (min)	Total cycle time (max filling)	Max H2O consumption (ml/cycle)	Average energy consumption (kWh/cycle)	TYPE	MAX TOTAL MASS (kg)	MAX MASS PER TRAY (kg)	MAX MASS PER ITEM (kg)		
134°C UNIVERSAL	134	2.1	4(*)	B	F	13	42	550	0.75	Unwrapped porous materials	1.00	0.30	0.30		
										Porous materials in single pack	0.75	0.25	0.25		
										Porous materials in double pack	0.60	0.20	0.20		
										Solid and hollow materials in single pack	3.00	1.00	0.50		
										Unwrapped solid and hollow materials	6.00	1.20	0.25		
										Solid and hollow instruments in double pack	1.50	0.50	0.25		
134°C PRION	134	2.1	18	B	F	13	56	600	0.85	Unwrapped porous materials	1.00	0.30	0.30		
										Porous materials in single pack	0.75	0.25	0.25		
										Porous materials in double pack	0.60	0.20	0.20		
										Solid and hollow materials in single pack	3.00	1.00	0.50		
										Unwrapped solid and hollow materials	6.00	1.20	0.25		
										Solid and hollow instruments in double pack	1.50	0.50	0.25		
121°C UNIVERSAL	121	1.1	20	B	F	13	58	600	0.75	Unwrapped porous materials	1.00	0.30	0.30		
										Porous materials in single pack	0.75	0.25	0.25		
										Porous materials in double pack	0.60	0.20	0.20		
										Solid and hollow materials in single pack	3.00	1.00	0.50		
										Unwrapped solid and hollow materials	6.00	1.20	0.25		
										Solid and hollow instruments in double pack	1.50	0.50	0.25		
134°C VELOCE	134	2.1	4(*)	S	F	1	22	450	0.65	Unwrapped hollow instruments	2.00	1.20	0.50		

For wrapped materials and instruments (single and double pack), it is advisable to use the 3-tray configuration

CYCLE DESCRIPTION	NOMINAL VALUES				BASIC CYCLE PARAMETERS					STERILIZABLE MATERIALS			NOTES	
	Temperature (°C)	Pressure (bar)	Retention time (min)	Cycle type (EN 13060:2014)	Pre-vacuum (F=fractionated; S=single)	Standard drying (min)	Total cycle time (max filling)	Max H2O consumption (ml/cycle)	Average energy consumption (kWh/cycle)	TYPE	MAX TOTAL MASS (kg)	MAX MASS PER TRAY (kg)		MAX MASS PER ITEM (kg)
										Unwrapped solid instruments	2.00	1.20	0.50	
134°C SOLID WRAPPED	134	2.1	4(*)	S	S	13	33	350	0.55	Solid and hollow instruments "B" in single pack	3.00	1.00	0.25	It is advisable to use the 3-tray configuration
										Unwrapped solid and hollow materials "B"	6.00	1.20	0.50	
XXX°C USER (see note)	134 - 121	2.1 - 1.1	4÷30 - 20÷30	n.a.	F/S	5÷30	n.a.	n.a.	n.a.	Unwrapped solid instruments (other load types are possible depending on the user settings)	n.a.	n.a.	n.a.	Variable parameters depending on the settings made
HELIX/BD TEST	134	2.1	3.5	-	F	1	20	-	-	Test device only (without another load)	-	-	-	
VACUUM TEST	-	-0.8	-	-	-	-	18	-	-	Empty chamber	-	-	-	
VACUUM + HELIX/BD TEST (executable in sequence)	-	-	-	-	-	-	42	-	-	-	-	-	-	

13.4. SUMMARY TABLE OF 17 120 V CYCLES

CYCLE DESCRIPTION	NOMINAL VALUES				BASIC CYCLE PARAMETERS						STERILIZABLE MATERIALS				NOTES
	Temperature (°C)	Pressure (bar)	Retention time (min)	Cycle type (EN 13060:2014)	Pre-vacuum (F=fractionated; S=single)	Standard drying (min)	Total cycle time (max filling)	Max H2O consumption (ml/cycle)	Average energy consumption (kWh/cycle)	TYPE	MAX TOTAL MASS (kg)	MAX MASS PER TRAY (kg)	MAX MASS PER ITEM (kg)		
135°C HOLLOW WRAPPED	135	2.2	4(*)	B	F	13	50	550	0.75	Unwrapped porous materials	1.00	0.30	0.30	For wrapped materials and instruments (single and double pack), it is advisable to use the 3-tray configuration	
										Porous materials in single pack	0.75	0.25	0.25		
										Porous materials in double pack	0.60	0.20	0.20		
										Solid and hollow materials in single pack	3.00	1.00	0.50		
										Unwrapped solid and hollow materials	6.00	1.20	0.25		
										Solid and hollow instruments in double pack	1.50	0.50	0.25		
135°C SOLID UNWRAPPED	135	2.2	4(*)	S	S	4	28	350	0.55	Unwrapped solid and hollow materials "B"	6.00	1.20	0.50		
121°C RUBBER & PLASTIC	121	1.1	20	B	F	13	69	600	0.75	Unwrapped porous materials	1.00	0.30	0.30	For wrapped materials and instruments (single and double pack), it is advisable to use the 3-tray configuration	
										Porous materials in single pack	0.75	0.25	0.25		
										Porous materials in double pack	0.60	0.20	0.20		
										Solid and hollow materials in single pack	3.00	1.00	0.50		
										Unwrapped solid and hollow materials	6.00	1.20	0.25		
										Solid and hollow instruments in double pack	1.50	0.50	0.25		
135° HOLLOW UNWRAPPED	135	2.2	4(*)	S	F	4	42	550	0.65	Unwrapped hollow instruments	6.00	1.20	0.50		
										Unwrapped solid instruments	6.00	1.20	0.50		
135°C SOLID WRAPPED	135	2.2	4(*)	S	S	13	39	350	0.55	Solid and hollow instruments "B" in single pack	3.00	1.00	0.25	It is advisable to use the 3-tray configuration	
										Unwrapped solid and hollow materials "B"	6.00	1.20	0.50		
XXX°C USER (see note)	135-121	2.2-1.1	4÷30 - 20÷30	n.a.	F	5÷30	n.a.	n.a.	n.a.	Unwrapped solid instruments (other load types are possible depending on the user settings)	n.a.	n.a.	n.a.	Variable parameters depending on the settings made	
HELIX/BD TEST	135	2.2	3.5	-	F	1	24	-	-	Test device only (without another load)	-	-	-		

CYCLE DESCRIPTION	NOMINAL VALUES				BASIC CYCLE PARAMETERS					STERILIZABLE MATERIALS				NOTES
	Temperature (°C)	Pressure (bar)	Retention time (min)	Cycle type (EN 13060:2014)	Pre-vacuum (F=fractionated; S=single)	Standard drying (min)	Total cycle time (max filling)	Max H2O consumption (ml/cycle)	Average energy consumption (kWh/cycle)	TYPE	MAX TOTAL MASS (kg)	MAX MASS PER TRAY (kg)	MAX MASS PER ITEM (kg)	
VACUUM TEST	-	-0.8	-	-	-	-	18	-	-	Empty chamber	-	-	-	
VACUUM + HELIX/BD TEST (executable in sequence)	-	-	-	-	-	-	50	-	-	-	-	-	-	

13.5. SUMMARY TABLE OF 22 220 V - 240 V CYCLES

CYCLE DESCRIPTION	NOMINAL VALUES				BASIC CYCLE PARAMETERS						STERILIZABLE MATERIALS				NOTES
	Temperature (°C)	Pressure (bar)	Retention time (min)	Cycle type (EN 13060:2014)	Pre-vacuum (F=fractionated; S=single)	Standard drying (min)	Total cycle time (max filling)	Max H2O consumption (ml/cycle)	Average energy consumption (kWh/cycle)	TYPE	MAX TOTAL MASS (kg)	MAX MASS PER TRAY (kg)	MAX MASS PER ITEM (kg)		
134°C UNIVERSAL	134	2.1	4(*)	B	F	15	46	700	0.8	Unwrapped porous materials	1.20	0.40	0.30		
										Porous materials in single pack	1.00	0.30	0.25		
										Porous materials in double pack	0.75	0.25	0.20		
										Solid and hollow materials in single pack	4.00	1.25	0.50		
										Unwrapped solid and hollow materials	7.50	1.20	0.25		
										Solid and hollow instruments in double pack	2.00	0.60	0.25		
134°C PRION	134	2.1	18	B	F	15	60	750	0.9	Unwrapped porous materials	1.20	0.40	0.30	For wrapped materials and instruments (single and double pack), it is advisable to use the 3-tray configuration	
										Porous materials in single pack	1.00	0.30	0.25		
										Porous materials in double pack	0.75	0.25	0.20		
										Solid and hollow materials in single pack	4.00	1.25	0.50		
										Unwrapped solid and hollow materials	7.50	1.20	0.25		
										Solid and hollow instruments in double pack	2.00	0.60	0.25		
121°C UNIVERSAL	121	1.1	20	B	F	15	63	750	0.8	Unwrapped porous materials	1.20	0.40	0.30		
										Porous materials in single pack	1.00	0.30	0.25		
										Porous materials in double pack	0.75	0.25	0.20		
										Solid and hollow materials in single pack	4.00	1.25	0.50		
										Unwrapped solid and hollow materials	7.50	1.20	0.25		
										Solid and hollow instruments in double pack	2.00	0.60	0.25		
134°C VELOCE	134	2.1	4(*)	S	F	1	25	500	0.65	Unwrapped hollow instruments	2.00	1.50	0.50		
										Unwrapped solid instruments	2.00	1.50	0.50		

CYCLE DESCRIPTION	NOMINAL VALUES				BASIC CYCLE PARAMETERS					STERILIZABLE MATERIALS			NOTES	
	Temperature (°C)	Pressure (bar)	Retention time (min)	Cycle type (EN 13060:2014)	Pre-vacuum (F=fractionated; S=single)	Standard drying (min)	Total cycle time (max filling)	Max H2O consumption (ml/cycle)	Average energy consumption (kWh/cycle)	TYPE	MAX TOTAL MASS (kg)	MAX MASS PER TRAY (kg)		MAX MASS PER ITEM (kg)
134°C SOLID WRAPPED	134	2.1	4(*)	S	S	15	39	400	0.6	Solid and hollow instruments "B" in single pack	4.00	1.00	0.25	It is advisable to use the 3-tray configuration
										Unwrapped solid and hollow materials "B"	7.50	1.20	0.50	
XXX°C USER (see note)	134-121	2.1-1.1	4÷30 - 20÷30	n.a.	F/S	5÷30	n.a.	n.a.	n.a.	Unwrapped solid instruments (other load types are possible depending on the user settings)	n.a.	n.a.	n.a.	Variable parameters depending on the settings made
HELIX/BD TEST	134	2.1	3.5	-	F	1	24	-	-	Test device only (without another load)	-	-	-	
VACUUM TEST	-	-0.8	-	-	-	-	18	-	-	Empty chamber	-	-	-	
VACUUM + HELIX/BD TEST (executable in sequence)	-	-	-	-	-	-	46	-	-	-	-	-	-	

13.6. SUMMARY TABLE OF 22 120 V CYCLES

CYCLE DESCRIPTION	NOMINAL VALUES				BASIC CYCLE PARAMETERS					STERILIZABLE MATERIALS				NOTES
	Temperature (°C)	Pressure (bar)	Retention time (min)	Cycle type (EN 13060:2014)	Pre-vacuum (F=fractionated; S=single)	Standard drying (min)	Total cycle time (Load Max)	Max H ₂ O consumption (ml/cycle)	Average energy consumption (kWh/cycle)	TYPE	MAX TOTAL MASS (kg)	MAX MASS PER TRAY (kg)	MAX MASS PER ITEM (kg)	
135°C HOLLOW WRAPPED	135	2.2	4(*)	B	F	15	55	550	0.8	Unwrapped porous materials	1.20	0.40	0.30	For wrapped materials and instruments (single and double pack), it is advisable to use the 3-tray configuration
										Porous materials in single pack	1.00	0.30	0.25	
										Porous materials in double pack	0.75	0.25	0.20	
										Solid and hollow materials in single pack	4.00	1.25	0.50	
										Unwrapped solid and hollow materials	7.50	1.20	0.25	
										Solid and hollow instruments in double pack	2.00	0.60	0.25	
135°C SOLID UNWRAPPED	135	2.2	4(*)	S	S	5	34	400	0.6	Unwrapped solid and hollow materials "B"	7.50	1.50	0.50	
121°C RUBBER & PLASTIC	121	1.1	20	B	F	15	75	750	0.8	Unwrapped porous materials	1.20	0.40	0.30	For wrapped materials and instruments (single and double pack), it is advisable to use the 3-tray configuration
										Porous materials in single pack	1.00	0.30	0.25	
										Porous materials in double pack	0.75	0.25	0.20	
										Solid and hollow materials in single pack	4.00	1.25	0.50	
										Unwrapped solid and hollow materials	7.50	1.20	0.25	
										Solid and hollow instruments in double pack	2.00	0.60	0.25	
135° HOLLOW UNWRAPPED	135	2.2	4(*)	S	F	5	46	750	0.7	Unwrapped hollow instruments	7.50	1.50	0.50	
										Unwrapped solid instruments	7.50	1.50	0.50	
135°C SOLID WRAPPED	135	2.2	4(*)	S	S	15	46	400	0.6	Solid and hollow instruments "B" in single pack	4.00	1.00	0.25	It is advisable to use the 3-tray configuration
										Unwrapped solid and hollow materials "B"	7.50	1.20	0.50	

CYCLE DESCRIPTION	NOMINAL VALUES				BASIC CYCLE PARAMETERS					STERILIZABLE MATERIALS			NOTES	
	Temperature (°C)	Pressure (bar)	Retention time (min)	Cycle type (EN 13060:2014)	Pre-vacuum (F=fractionated; S=single)	Standard drying (min)	Total cycle time (Load Max)	Max H2O consumption (ml/cycle)	Average energy consumption (kWh/cycle)	TYPE	MAX TOTAL MASS (kg)	MAX MASS PER TRAY (kg)		MAX MASS PER ITEM (kg)
XXX°C USER (see note)	135-121	2.2-1.1	4÷30 - 20÷30	n.a.	F	5÷30	n.a.	n.a.	n.a.	Unwrapped solid instruments (other load types are possible depending on the user settings)	n.a.	n.a.	n.a.	Variable parameters depending on the settings made
HELIX/BD TEST	135	2.2	3.5	-	F	1	24	-	-	Test device only (without another load)	-	-	-	
VACUUM TEST	-	-0.8	-	-	-	-	18	-	-	Empty chamber	-	-	-	
VACUUM + HELIX/BD TEST (executable in sequence)	-	-	-	-	-	-	50	-	-	-	-	-	-	

13.7. SUMMARY TABLE OF 28 220 V - 240 V CYCLES

CYCLE DESCRIPTION	NOMINAL VALUES				BASIC CYCLE PARAMETERS						STERILIZABLE MATERIALS				NOTES
	Temperature (°C)	Pressure (bar)	Retention time (min)	Cycle type (EN 13060:2014)	Pre-vacuum (F=fractionated; S=single)	Standard drying (min)	Total cycle time (max filling)	Max H2O consumption (ml/cycle)	Average energy consumption (kWh/cycle)	TYPE	MAX TOTAL MASS (kg)	MAX MASS PER TRAY (kg)	MAX MASS PER ITEM (kg)		
134°C UNIVERSAL	134	2.1	4(*)	B	F	17	56	900	0.8	Unwrapped porous materials	1.50	0.50	0.50		
										Porous materials in single pack	1.25	0.35	0.35		
										Porous materials in double pack	0.90	0.30	0.30		
										Solid and hollow materials in single pack	5.00	1.50	0.75		
										Unwrapped solid and hollow materials	9.00	1.40	0.25		
										Solid and hollow instruments in double pack	2.50	0.70	0.25		
134°C PRION	134	2.1	18	B	F	17	70	950	1	Unwrapped porous materials	1.50	0.50	0.50		
										Porous materials in single pack	1.25	0.35	0.35		
										Porous materials in double pack	0.90	0.30	0.30		
										Solid and hollow materials in single pack	5.00	1.50	0.75		
										Unwrapped solid and hollow materials	9.00	1.40	0.25		
										Solid and hollow instruments in double pack	2.50	0.70	0.25		
121°C UNIVERSAL	121	1.1	20	B	F	17	69	950	0.9	Unwrapped porous materials	1.50	0.50	0.50		
										Porous materials in single pack	1.25	0.35	0.35		
										Porous materials in double pack	0.90	0.30	0.30		
										Solid and hollow materials in single pack	5.00	1.50	0.75		
										Unwrapped solid and hollow materials	9.00	1.40	0.25		
										Solid and hollow instruments in double pack	2.50	0.70	0.25		
134°C VELOCE	134	2.1	4(*)	S	F	1	28	600	0.65	Unwrapped hollow instruments	2.00	1.50	0.50		

For wrapped materials and instruments (single and double pack), it is advisable to use the 3-tray configuration

CYCLE DESCRIPTION	NOMINAL VALUES				BASIC CYCLE PARAMETERS					STERILIZABLE MATERIALS				NOTES
	Temperature (°C)	Pressure (bar)	Retention time (min)	Cycle type (EN 13060:2014)	Pre-vacuum (F=fractionated; S=single)	Standard drying (min)	Total cycle time (max filling)	Max H2O consumption (ml/cycle)	Average energy consumption (kWh/cycle)	TYPE	MAX TOTAL MASS (kg)	MAX MASS PER TRAY (kg)	MAX MASS PER ITEM (kg)	
										Unwrapped solid instruments	2.00	1.50	0.50	
134°C SOLID WRAPPED	134	2.1	4(*)	S	S	17	45	500	0.7	Solid and hollow instruments "B" in single pack	5.00	1.00	0.25	It is advisable to use the 3-tray configuration
										Unwrapped solid and hollow materials "B"	9.00	1.20	0.50	
XXX°C USER (see note)	134-121	2.1-1.1	4÷30 - 20÷30	n.a.	F/S	5÷30	n.a.	n.a.	n.a.	Unwrapped solid instruments (other load types are possible depending on the user settings)	n.a.	n.a.	n.a.	Variable parameters depending on the settings made
HELIX/BD TEST	134	2.1	3.5	-	F	1	24	-	-	Test device only (without another load)	-	-	-	
VACUUM TEST	-	-0.8	-	-	-	-	18	-	-	Empty chamber	-	-	-	
VACUUM + HELIX/BD TEST (executable in sequence)	-	-	-	-	-	-	46	-	-	-	-	-	-	

13.8. SUMMARY TABLE OF 28 120 V CYCLES

CYCLE DESCRIPTION	NOMINAL VALUES				BASIC CYCLE PARAMETERS					STERILIZABLE MATERIALS				NOTES
	Temperature (°C)	Pressure (bar)	Retention time (min)	Cycle type (EN 13060:2014)	Pre-vacuum (F=fractionated; S=single)	Standard drying (min)	Total cycle time (Load Max)	Max H2O consumption (ml/cycle)	Average energy consumption (kWh/cycle)	TYPE	MAX TOTAL MASS (kg)	MAX MASS PER TRAY (kg)	MAX MASS PER ITEM (kg)	
135°C HOLLOW WRAPPED	135	2.2	4(*)	B	F	17	67	900	0.8	Unwrapped porous materials	1.50	0.50	0.50	For wrapped materials and instruments (single and double pack), it is advisable to use the 3-tray configuration
										Porous materials in single pack	1.25	0.35	0.35	
										Porous materials in double pack	0.90	0.30	0.30	
										Solid and hollow materials in single pack	5.00	1.50	0.75	
										Unwrapped solid and hollow materials	9.00	1.40	0.25	
										Solid and hollow instruments in double pack	2.50	0.70	0.25	
135°C SOLID UNWRAPPED	135	2.2	4(*)	S	S	6	40	500	0.6	Unwrapped solid and hollow materials "B"	9.00	1.50	0.50	
121°C RUBBER & PLASTIC	121	1.1	20	B	F	17	82	950	0.8	Unwrapped porous materials	1.50	0.50	0.50	For wrapped materials and instruments (single and double pack), it is advisable to use the 3-tray configuration
										Porous materials in single pack	1.25	0.35	0.35	
										Porous materials in double pack	0.90	0.30	0.30	
										Solid and hollow materials in single pack	5.00	1.50	0.75	
										Unwrapped solid and hollow materials	9.00	1.40	0.25	
										Solid and hollow instruments in double pack	2.50	0.70	0.25	
135° HOLLOW UNWRAPPED	135	2.2	4(*)	S	F	6	52	950	0.7	Unwrapped hollow instruments	9.00	1.50	0.50	
										Unwrapped solid instruments	9.00	1.50	0.50	
135°C SOLID WRAPPED	135	2.2	4(*)	S	S	17	54	500	0.6	Solid and hollow instruments "B" in single pack	5.00	1.00	0.25	It is advisable to use the 3-tray configuration
										Unwrapped solid and hollow materials "B"	9.00	1.20	0.50	
XXX°C USER (see note)	135-121	2.2-1.1	4÷30 - 20÷30	n.a.	F	5÷30	n.a.	n.a.	n.a.	Unwrapped solid instruments (other load types are possible depending on the user settings)	n.a.	n.a.	n.a.	Variable parameters depending on the settings made

CYCLE DESCRIPTION	NOMINAL VALUES				BASIC CYCLE PARAMETERS					STERILIZABLE MATERIALS			NOTES	
	Temperature (°C)	Pressure (bar)	Retention time (min)	Cycle type (EN 13060:2014)	Pre-vacuum (F=fractionated, S=single)	Standard drying (min)	Total cycle time (Load Max)	Max H2O consumption (ml/cycle)	Average energy consumption (kWh/cycle)	TYPE	MAX TOTAL MASS (kg)	MAX MASS PER TRAY (kg)		MAX MASS PER ITEM (kg)
HELIX/BD TEST	135	2.2	3.5	-	F	1	24	-	-	Test device only (without another load)	-	-	-	
VACUUM TEST	-	-0.8	-	-	-	-	18	-	-	Empty chamber	-	-	-	
VACUUM + HELIX/BD TEST (executable in sequence)	-	-	-	-	-	-	50	-	-	-	-	-	-	

 (*) To set a sterilization time of 5.5 minutes, contact the Technical Service.
 Single Pre-Vacuum = 1 pre-vacuum; -0.8 bar (see figures in the following pages).
 Fractionated Pre-Vacuum = 3 pre-vacuum; -0.8 bar each (see figures in the following pages).
 Definition of hollow loads in accordance with standard EN13060:2014.
 The term "hollow loads" in this manual refers both to "narrow lumen" elements (paragraph 3.18 EN 13060:2014) and "simple hollow" elements (paragraph 3.30 EN 13060:2014).
 The term "hollow load B" refers ONLY to the elements defined as "simple hollow" (paragraph 3.30 EN 13060:2014).

PRESSURE, TIME AND TEMPERATURE
In compliance with EN 13060: 2014 for operating cycles

134°C cycles

EN 13060:2014		Time (minutes)	Min temperature	Max temperature	Min pressure (bar)	Max pressure (bar)
1	CS	---	---	---	---	---
t1	1PV	---	---	---	-0.81 * (-0.76)	-0.79 * (-0.74)
t2	1PP	---	---	---	+0.97 * (+0.27)	+1.03 * (+0.33)
t3	2PV	---	---	---	-0.81 * (-0.76)	-0.79 * (-0.74)
t4	2PP	---	---	---	+0.97 * (+0.27)	+1.03 * (+0.33)
t5	3PV	---	---	---	-0.81 * (-0.76)	-0.79 * (-0.74)
t6	SS	4 / 5.5	+134	+138	+2.04	+2.40
t7	SE	4 / 5.5	+134	+138	+2.04	+2.40
t8	DS	---	---	---	-0.81 * (-0.76)	-0.79 * (-0.74)
t9	DE	---	---	---	---	---
2	CE	---	---	---	-0.02	+0.02

* Parameters referred to cycle S 134° VELOCE.

121°C cycles

EN 13060:2014		Time (minutes)	Min temperature	Max temperature	Min pressure (bar)	Max pressure (bar)
1	CS	---	---	---	---	---
t1	1PV	---	---	---	-0.81	-0.79
t2	1PP	---	---	---	+0.97	+1.03
t3	2PV	---	---	---	-0.81	-0.79
t4	2PP	---	---	---	+0.97	+1.03
t5	3PV	---	---	---	-0.81	-0.79
t6	SS	20	+121	+125	+1.05	+1.31
t7	SE	20	+121	+125	+1.05	+1.31
t8	DS	---	---	---	-0.81	-0.79
t9	DE	---	---	---	---	---
2	CE	---	---	---	-0.02	+0.02

13.9. STERILISATION PROGRAM DIAGRAM

PROGRAM
134°C UNIVERSAL
134°C – 4' 00"

- A** PRESSURE (BAR)
- B** PROCESS
- C** TIME (MIN)
- D** FRACTIONATED VACUUM
- E** VACUUM DRYING

PROGRAM
134°C PRION
134°C – 18' 00"

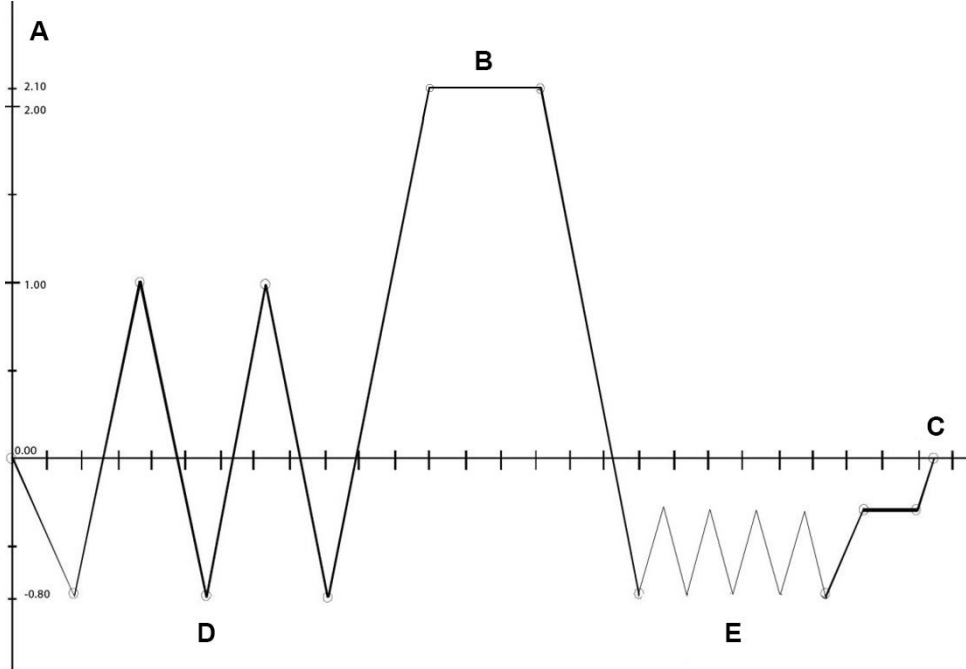

PROGRAM
121°C UNIVERSAL
121°C – 20' 00"

- A** PRESSURE (BAR)
- B** PROCESS
- C** TIME (MIN)
- F** FRACTIONATED PRE-VACUUM
- G** LONG DRYING

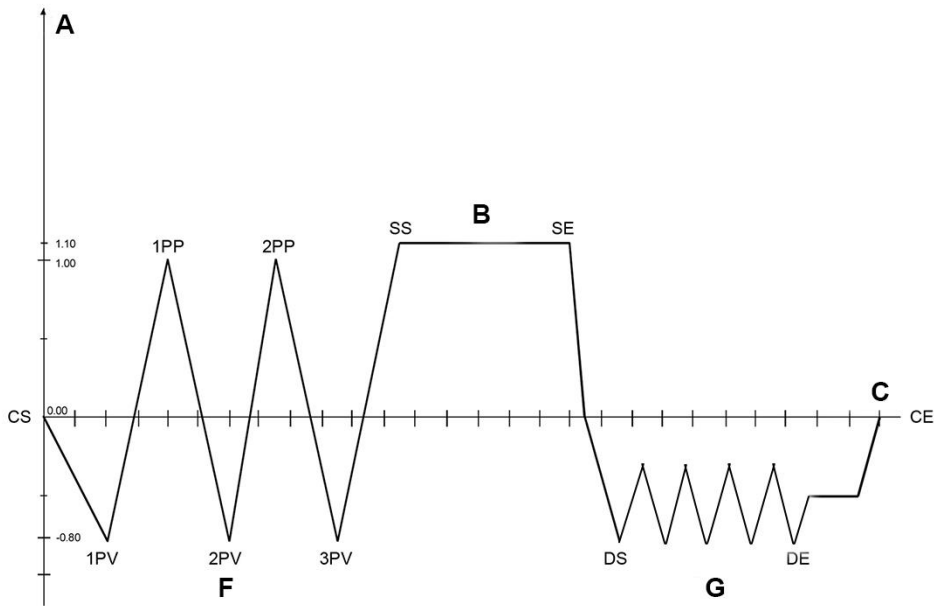

PROGRAM
134°C VELOCE
134°C - 4'00''

A PRESSURE (BAR)
B PROCESS
C TIME (MIN)
F FRACTIONATED PRE-VACUUM
H SHORT DRYING

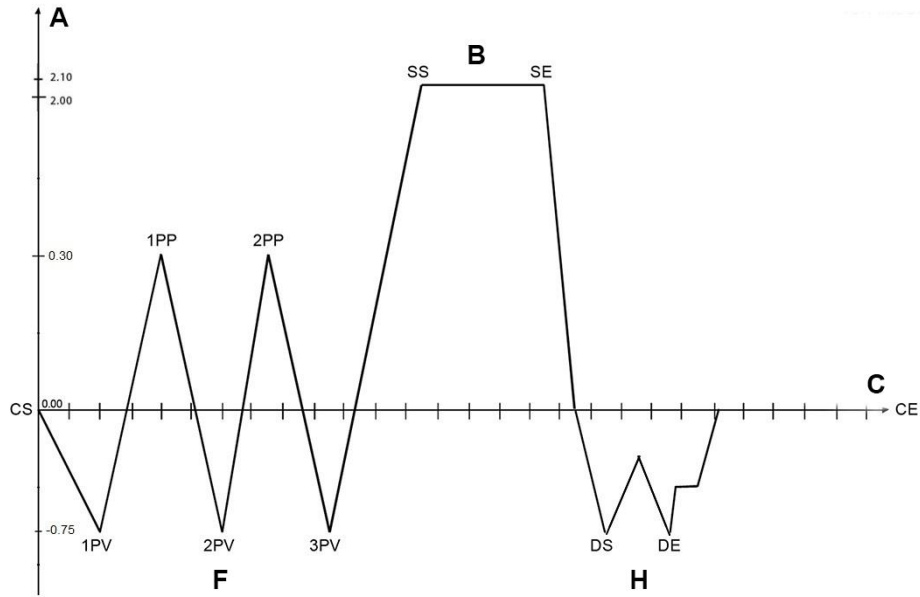

PROGRAM
134°C SOLID WRAPPED
134°C - 4'00''

A PRESSURE (BAR)
B PROCESS
C TIME (MIN)
I SINGLE PRE-VACUUM
G LONG DRYING

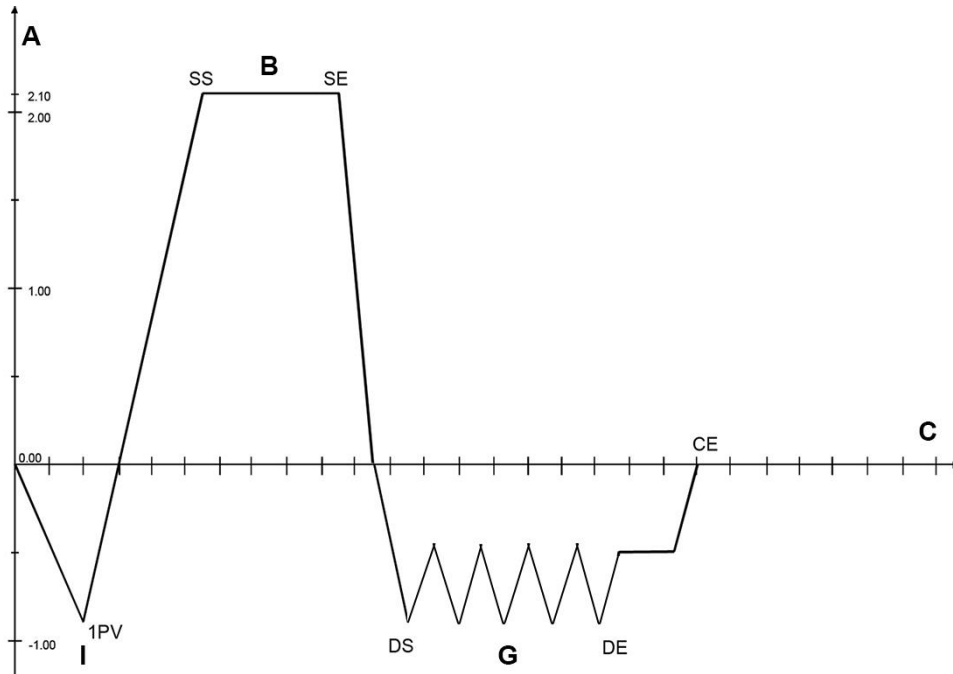

13.10. DIAGRAMS OF THE TEST PROGRAMMES

PROGRAM
HELIX B&D TEST
134°C – 3'00''
(Not provided for S versions)

- A** PRESSURE (BAR)
- B** PROCESS
- C** TIME (MIN)
- F** FRACTIONATED PRE-VACUUM
- H** SHORT DRYING

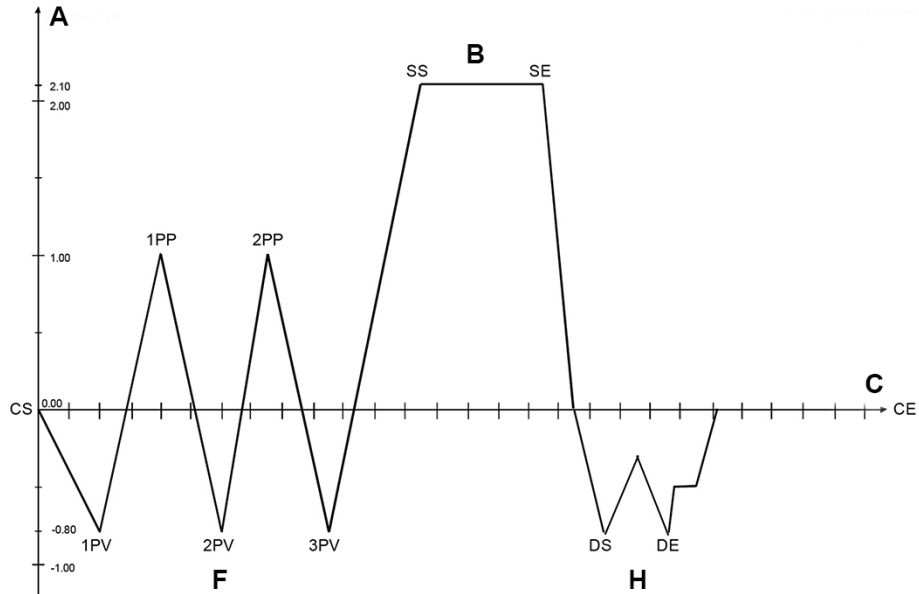

PROGRAM
VACUUM TEST
-0.80 bar

- A** PRESSURE (BAR)
- C** TIME (MIN)
- L** INTERMEDIATE CONDITION TO CONTINUE THE TEST
- M** FINAL CONDITION TO PASS THE TEST
- N** VACUUM PHASE
- O** STANDBY
- P** LOSS MEASUREMENT

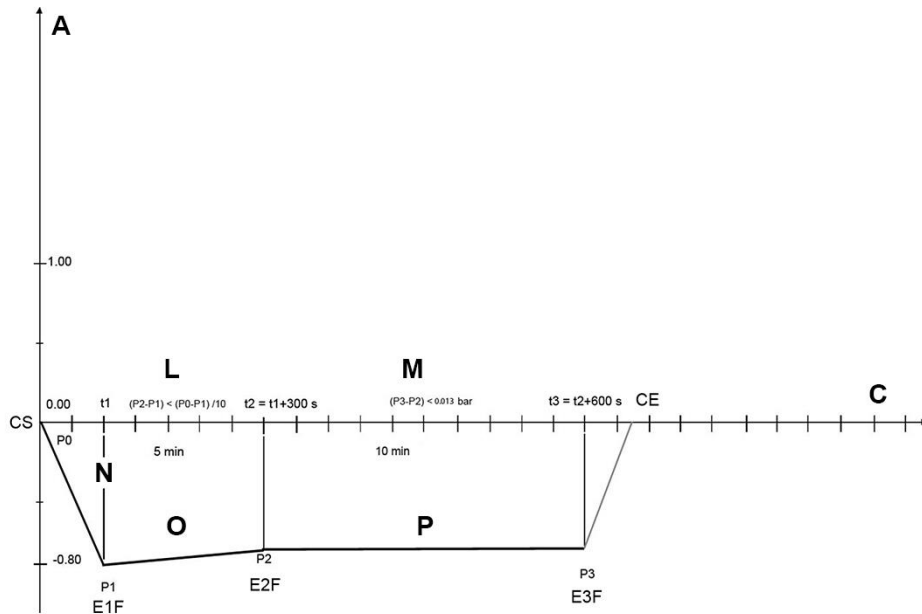

14. APPENDIX - MAINTENANCE

In addition to correct use, the user needs to perform ordinary maintenance in order to guarantee safe, efficient operation over the device's entire life.



Always use personal protective equipment.



For better quality of maintenance, supplement routine checks with regular periodic check-ups that can be performed by Technical Service Department (see *Appendix*).

It is also fundamental to perform a **periodic sterilizer validation**, i.e. a check of process thermo-dynamic parameters and their comparison with the reference values detected by duly calibrated tools. Refer to 'Sterilizer periodic validation' in the next part of the Appendix.

The ordinary maintenance described below consists in easy manual operations and preventive interventions involving simple instruments.



In the event of replacement of components or parts of the device, request and/or use original spare parts only.

14.1. ORDINARY MAINTENANCE PROGRAMME

The table summarizes the maintenance interventions required to maintain the sterilizer in good working order.

In case of **heavy use**, we recommend to **shorten** maintenance intervals:

DAILY	Clean the gasket and the internal part of the door Clean external surfaces
WEEKLY	Clean the sterilization chamber and its accessories Disinfect external surfaces Clean/disinfect filling/drainage tanks
PERIODICALLY	See Scheduled Maintenance messages
YEARLY	Validate sterilizer (<i>see scheduled maintenance</i>)

14.2. SCHEDULED MAINTENANCE MESSAGES

The sterilizer periodically displays warning messages relevant to "routine" maintenance operations that must be carried out in order to ensure the proper operation of the device.

Press OK to confirm that the required maintenance operation has been completed.

Press  button to postpone the operation.

In this case, the warning message will reappear the next time the sterilizer is used.

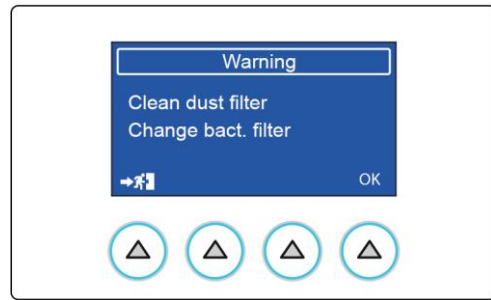

Warnings are displayed with the following frequency:

WARNING MESSAGE

BOILER FILTER CLEANING

DOOR LOCK LUBRICATION

DUST FILTER CLEANING

BACTERIOLOGICAL FILTER REPLACEMENT

WATER TANK CLEANING

BOILER GASKET REPLACEMENT

GENERAL SERVICE

 *A regular maintenance is essential to achieve the best performance of the device. Periodically, a message will be displayed requesting that the above maintenance operations are performed. For further information or in case of doubt, contact the technical service: if they have performed regular maintenance on the device, the technician might have already carried out some of these operations (e.g. >Replacement of the bacteriological filter or of the gasket).*

Always keep in mind the following **general warnings**:

- **Do not** wash the sterilizer with direct jets of water, neither under pressure nor sprinkled. Seepage into electrical and electronic components could damage the functioning of the device or its internal parts, even irreparably;
- **Do not** use abrasive cloths, metal brushes (or other aggressive materials) or products for metal cleaning, both solid and liquid, to clean the device or the sterilization chamber;
- **Do not** use unsuitable chemical products or disinfectants to clean the sterilization chamber. In fact, these products can cause damages, even irreparably;
- **Do not** allow limescale or residues of other substances to accumulate in the sterilization chamber, on the door and on the gasket, but remove them periodically. In fact, such residues may damage these parts, besides compromising the operation of the hydraulic circuit components.

 *The formation of white spots on the base of the internal wall of the chamber means that you are using poor quality demineralised water.*

 **Before performing ordinary maintenance, make sure that the power cord plug is removed from the mains socket. If this is not possible, move the external switch of the device's power supply line to Off. If the external switch is distant or not visible to the maintainer, place a "work in progress" sign on the switch, after turning it off.**

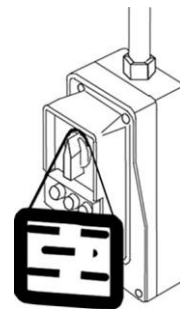

14.3. DESCRIPTION OF MAINTENANCE INTERVENTIONS

Let's now look at the various operations to be carried out.

14.3.1. CLEAN GASKET AND PORTHOLE

To eliminate any traces of limestone, clean the gasket of the chamber and the door porthole with a clean cotton cloth soaked in a soft solution of water and vinegar (or a similar product, checking the contents on the label before using).

Dry the surfaces and remove any residues before using the device.

14.3.2. CLEAN STERILIZATION CHAMBER AND ACCESSORIES

Clean the sterilization chamber, support and trays (and internal surfaces in general) with a clean cotton cloth soaked in water and, possibly, the addition of a small amount of neutral detergent.

Carefully rinse with distilled water, taking care not to leave any type of residue in the chamber or on accessories.



*Do not use pointed or sharp tools to remove scale from the sterilization chamber.
Should there be evident deposits, immediately check the quality of the distilled water used (see technical characteristics appendix).*

14.3.3. EXTERNAL SURFACE CLEANING AND DISINFECTION

To clean and disinfect the external surfaces, we recommend using STER 1 PLUS or ethyl alcohol diluted with 50% water. Apply product with a soaked cloth, then dry.

As an alternative, we recommend using products containing the following at no more than the given concentration:

- **Ethanol.** Concentration: maximum 30 g per 100 g of disinfectant.
- **1-Propanol (n-propanol, propyl alcohol, n-propyl alcohol).** Concentration: maximum 20 g per 100 g of disinfectant.
- **Combination of ethanol and propanol.** Concentration: the combination of the two must be maximum 40 g per 100 g of disinfectant.



**Do not spray or vaporise any product directly on device surfaces.
Inflammable liquid.**

14.3.4. CLEANING AND DISINFECTION OF FILTERS AND TANK

Clean and disinfect filters and internal walls only of the tank with a disposable wipe/cloth soaked in 70% ethyl alcohol.



Do not use 70% alcohol to disinfect the other plastic surfaces

14.3.5. BOILER FILTER CLEANING

With use it is likely that various residues accumulate in the filter and with time obstruct the lower drain duct.

To clean the filter, open the sterilizer door and remove the cap using a coin or another suitable tool.

Loosen the union that contains the filter.

Remove the filter from its support and thoroughly clean it under a jet of running water, if necessary using a sharp tool to remove any large foreign bodies (if possible use a jet of compressed air).

If it is impossible to recover the filter, replace it with a new one.

Refit everything operating in reverse order and making sure to screw the union in such a way that the drain holes are positioned **at the level of the boiler wall**.



*Properly fit the filter in its housing.
A partial fitting may damage the component.*

14.3.6. DOOR LOCK LUBRICATION

Using a clean cloth, remove any residues from the bushing and the screw.

Lubricate the inside of the bushing on the sterilizer door with a film of the silicon-based grease provided (as shown in the figure).



*Wear single-use gloves before application.
Essentially, the lubricant is not irritant to the skin; nevertheless, it may cause unpleasant effects if it accidentally comes into contact with eyes.
In case of contact with eyes, rinse with plenty of water.*

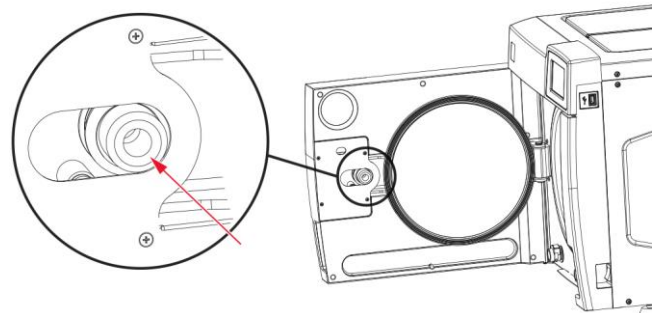

14.3.7. ANTI-DUST FILTER CLEANING

Remove the dust filter (A) from the lower part of the autoclave, thoroughly rinse it with water and dry it before refitting it.

The filter can be cleaned using a jet of compressed air, making sure not to disperse any dust into the environment.

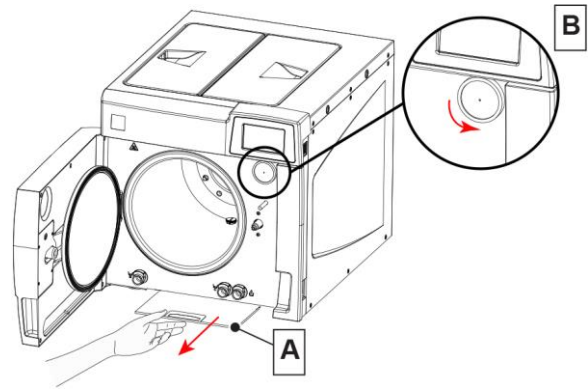

14.3.8. REPLACE THE BACTERIOLOGICAL FILTER

When filter maintenance is due or every time you notice visible clogging of the filter (indicated by the filter markedly turning grey), unscrew the bacteriological filter (B) from its support and replace it with a new one, screwing it fully down on the union.

A spare bacteriological filter is provided with the device (not provided for S versions).
If you need spare parts of this component, refer to technical assistance [appendix](#).

14.3.9. WATER TANK CLEANING

Empty the tanks (C) containing the autoclave filling and drainage water, remove any deposits around the filters (D) on the bottom of the tanks (see figure).

After removing and cleaning the filters, wipe the inside of the tanks with a dry cloth and clean thoroughly.

After cleaning the filters (D), refit them inside the tanks (C)

Do not use cleaning products inside the tank.
Only use a dry cloth.

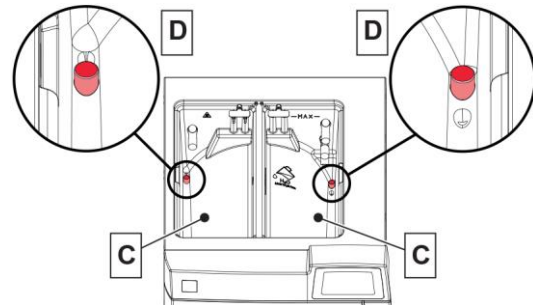

14.3.10. BOILER GASKET REPLACEMENT

It is advisable to have the boiler gasket replaced by an authorised technician, therefore contact Technical Service (see **APPENDIX – TECHNICAL SERVICE**).

14.4. PERIODIC STERILIZER VALIDATION

As happens with all devices, it is possible, and sometimes inevitable, to have a decrease in performance and the effectiveness of components along their lifespan, in a period of time dependent on its frequency of use.

To guarantee the safety of the process over time, it is periodically (possibly annually) necessary to **verify** the **thermodynamic process parameters** (pressure and temperature), to check if they continue to remain within allowed limits or not.

The requalification of the sterilizer's performance is the **responsibility of the user** of the product.

The reference European standards **EN 17665** (Sterilization of the medical devices - Method for the validation and systematic control of the steam sterilization) and **EN 556** (Sterilization of the medical devices – Requirements for the medical devices marked with “STERILE” indication) supply an effective guide tool for carrying out the verifications on the steam sterilizers.

Since, in addition to specific experience and training, these controls require the use of special equipment (high-precision sensors and probes, data loggers, dedicated software, etc.) suitably verified and calibrated, it is necessary to contact a **company specializing** in these activities.

Customer support department (see [Appendix](#)) is available to provide any information relative to the periodic validation of steam sterilizers.

14.5. DEVICE USEFUL LIFE

Water steam sterilizer service life is of 10 years (average use: 5 cycles/day, for 220 days/year). For normal use, it is expected that the device is used and maintained according to the instructions provided by the manufacturer.

14.6. DISPOSING THE EQUIPMENT WHEN NO LONGER USED

According to Directive 2012/19/EU concerning waste disposal, the units must not be disposed of as municipal waste, but must be separated. When purchasing a new device of an equivalent type, one for one, the device that has come to the end of its lifetime should be returned to the dealer for disposal.

As regards reuse, recycling and other forms of recovery of the above mentioned waste, the manufacturer carries out the functions defined in the individual national legislations.

Appropriate differentiated waste collection for subsequent recycling treatment and environmentally friendly disposal contributes to preventing possible negative effects on the environment and health and encourages recycling of the materials of which the device is made up. The symbol indicating separate collection for electrical and electronic equipment consists of the crossed out bin marked on the device.



Under national legislation, fines can be imposed if the product is disposed in an illegal manner.

15. APPENDIX - GENERAL PROBLEMS



If while using the device a problem or an alarm occurs, this **DOES NOT** mean that the device is out of order. It may not, in fact, be related to a breakdown but, more probably to an anomalous situation, often merely transitory (such as a blackout), or incorrect use.

In any case, it is important to first identify the cause of the failure and then take suitable corrective actions, either autonomously or with the intervention of the **Technical Service Department** (see Appendix).

For this purpose, below, we provide instructions for diagnosing and resolving general problems, in addition to a precise description of the alarm codes, their meaning and their solution.

15.1. TROUBLESHOOTING

If your sterilizer is not working correctly, please make the following checks before contacting the Technical Service Department:

PROBLEM	POSSIBLE CAUSE	SUGGESTED SOLUTION
The sterilizer does not power-on.	The power cable is not plugged-in.	Plug it in.
	Lack of voltage at the power supply socket.	Check the cause of the lack of voltage at socket and fix it.
	The main switch and/or differential switch are turned to OFF.	Turn the switch to ON.
	The mains fuses are blown.	Replace with good fuses of equal nominal value. (See the Summary Table in Appendix, Technical Characteristics).
After pressing START, the sterilization cycle does not start.	The device is preheating.	Wait for the sterilizer to reach the proper operating conditions for starting the program.  <i>Under standard conditions, the Average Preheating Time is about 10-15 Minutes.</i>
The safety valve has triggered.	Locking ring loosened. Presence of anomalous overpressure in the chamber.	Check the proper tightening of the milled ring nut of the safety valve.  Let the device cool or use gloves to prevent burns while touching the valve.
Water presence on the sterilizer resting surface.	The water automatic filling system hose (optional) is not correctly connected.	Check the tightness of the fittings and, if necessary, reassemble them more carefully. Check that the hoses are completely inserted on the fittings; check the presence of hose clamps.
	Steam leak from door gasket.	At the end of the cycle clean the gasket and the closing porthole with a dampened cloth. Check the presence of any gasket damage. Perform a new verification cycle.
Excessive humidity on the material and/or instruments at the end of the program.	Excessive load in the sterilization chamber.	Check that the load does not exceed the maximum values allowed (See the Summary Table in Appendix "Technical Characteristics").
	Load not correctly positioned.	Position the load, in particular the wrapped one, as per the indications. (See Chapter "Preparing the material").
	Wrong selection of the sterilization program.	Choose the sterilization program suitable for the type of material to be treated. (See the Summary Table in "Programs" Appendix).
	Clogged chamber drainage filter.	Clean or replace the drainage filter. (See Appendix "Maintenance").
Traces of oxidation or spots on instruments	Quality of the instruments not adequate.	Check the quality of instruments, making sure that the material they are made of is suitable to tolerate the steam sterilization.

PROBLEM	POSSIBLE CAUSE	SUGGESTED SOLUTION
	Quality of the distilled water not adequate.	Empty the tank and fill it with high-quality distilled water. (See Water supply characteristics in " Technical characteristics " Appendix).
	Organic or inorganic residues on the instruments.	Carefully clean the material before subjecting it to the sterilization cycle. (See Chapter " Preparing the material ").
	Contact between instruments made of different metals.	Separate instruments made of different metals. (See Chapter " Preparing the material ").
	Presence of limescale residues on the wall of the chamber and/or accessories.	Clean the chamber and the accessories as prescribed. (See Appendix " Maintenance ").
Blackening of the instruments or damage to the material.	Wrong selection of the sterilization program.	Choose the sterilization program suitable for the type of material to be treated. (See the Summary Table in " Programs " Appendix).

16. APPENDIX – ALARMS

 If the problem persists, contact the technical service (see [APPENDIX](#)) communicating the sterilizer model and serial number. These data are indicated on the registration plate on the rear side of the device and on the declaration of conformity and can be viewed also by means of the “sterilizer information” command.

Every time an **anomalous condition** occurs during the operation of the sterilizer, an alarm is generated, identified by a specific code (consisting of a letter followed by a 3-digit number).

Alarm codes are divided into **four categories**:

E= ERROR/WARNING

Incorrect handling and/or use or a cause outside the device.

The problem can normally be solved by the user.

Code format: **Exxx** (xxx = identification number 000 ÷ 999)

A = ALARM

First level fault

The problem can normally be solved on site by a specialised technician.

Code format: **Axxx** (xxx = identification number 000 ÷ 999)

H = HAZARD

Second level fault

The problem can normally be solved by the Technical Service Centre.

Code format: **Hxxx** (xxx = identification number 000 ÷ 999)

S = SYSTEM ERROR

Electronic system error (HW-FW).

Code format: **Sxxx** (xxx = identification number 000 ÷ 999)

 In case of alarm, switch off the device only after having followed the indications displayed and having carried out the reset (see “Resetting the system” paragraph).

16.1. ALARM INTERVENTION

The alarm intervention causes the **cycle interruption** (or the normal operation interruption), the display of the relevant **alarm code** and **message** and an **audible warning**.

16.2. ALARM DURING A CYCLE

The alarm procedure is designed in order **not** to give the user any possibility to **confuse** an anomalous cycle with an efficiently carried out one, and therefore to **unintentionally use not sterilised materials**; it is structured to guide the user up to the **RESET** of the sterilizer and the following use.

16.3. SYSTEM RESET

The system can be reset in two alternative ways, depending on the type of alarm occurred (see the **List of alarm codes** below in this appendix):

- 1 Pressing the OK button;
- 2 Following the instructions displayed and holding down the RESET button for about 3 seconds.

Press the "padlock" button for 3 seconds to open the sterilizer door:

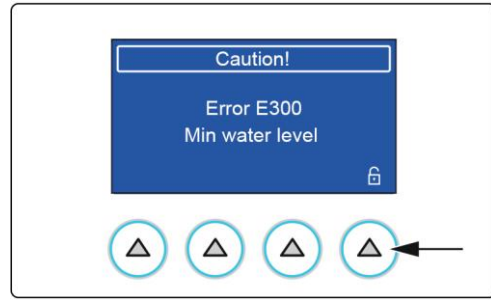

Press the RESET button for approx. 3 seconds to go back to the main menu.

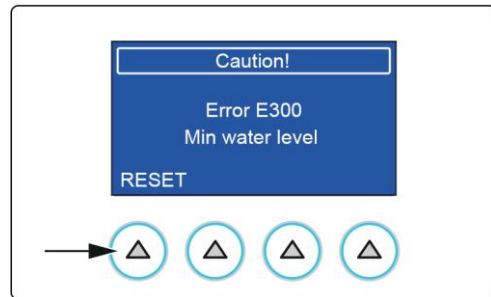

After the RESET and any technical operation necessary to eliminate the fault, the device will be ready to perform a new program.



Never turn off the device before carrying out the reset.

17. ALARM CODES

The **list** of alarm codes, the relevant messages displayed and RESET modes, are indicated in the following table:

17.1. ERRORS (CATEGORY E)

The alarm codes in the list can refer to functions that are not present on the models concerned in this Manual

CODE	ALARM DESCRIPTION	MESSAGE ON THE DISPLAY	RESET MODE
E000	Black-out	POWER OUTAGE CONTACT TECH. SERVICE	2, 3
E001	Voltage of power supply line too high	OVERVOLTAGE CONTACT TECH. SERVICE	2, 3
E002	Water conductivity threshold 1 exceeded	INSUFFICIENT H2O QUALITY	1
E003	Water conductivity threshold 2 exceeded	QUALITY H2O BAD CHANGE WATER	1
E004	Error in electrical mains frequency reading	LINE FREQ. ERROR CONTACT TECH. SERVICE	1
E007	One of the two fans is not working properly	FAN PROBLEM CONTACT TECH. SERVICE	1
E008	Water conductivity threshold 1 exceeded	FILTERS NEARLY EXHAUSTED	1
E009	Water conductivity threshold 2 exceeded	QUALITY H2O BAD CHANGE FILTERS CHANGE WATER	1
E010	Door open	DOOR OPEN CLOSE DOOR	2
E020	Door lock system (closing) activation time-out exceeded	DOOR CLOSING ERROR CONTACT TECH. SERVICE	2, 3
E021	Door lock system (opening) activation time-out exceeded	DOOR OPENING ERROR CONTACT TECH. SERVICE	1
E022	Door lock microswitches failure.	DOOR LOCK PROBLEM CONTACT TECH. SERVICE	1
E030	The water in the feed tank is at minimum level (MIN)	LOAD TANK MINIMUM LEVEL FILL TANK	2
E031	Maximum level of water in the drainage tank (MAX)	DISCHARGE TANK MAXIMUM LEVEL EMPTY TANK	2
E042	The MAX water level in the filling tank has been reached	LOAD TANK MAXIMUM LEVEL	1
E050	Reminder to run Vacuum Test cycle	TEST REMINDER RUN VACUUM TEST	1
E051	Reminder to run Helix Test cycle	TEST REMINDER RUN HELIX TEST	1
E052	Reminder to run Vacuum + Helix Test combined cycle	TEST REMINDER RUN VACUUM+HELIX TEST	1
E060	The autoclave cannot connect to Lan network	ETHERNET CONFIG. ERROR CHECK SETTINGS	1
E061	The autoclave cannot connect to Wi-Fi network	Wi-Fi CONFIG. ERROR CHECK SETTINGS	1
E070	Preheating activation with door open	PREHEATING ACTIVATED IT IS ADVISABLE TO CLOSE THE DOOR	1
E126	Cloud firmware update in progress	CLOUD FW UPDATE PLEASE WAIT...	1

CODE	ALARM DESCRIPTION	MESSAGE ON THE DISPLAY	RESET MODE
E130	Cycle disabled by a service technician	CYCLE NOT ENABLED	1
E141	Cloud firmware version is not the correct one compared to Process firmware version. Malfunctions may occur during connection with Wi-Fi, Ethernet or Cloud	CLOUD FW VERSION NOT CORRECT PLEASE UPDATE THE FW	1
E900	Vacuum test failed (during TEST PHASE)	TEST FAILED SECOND STEP CONTACT TECH. SERVICE	3
E901	Vacuum test failed (during STAND-BY PHASE)	TEST FAILED FIRST STEP CONTACT TECH. SERVICE	3
E902	Vacuum test failed (vacuum pulse time-out exceeded)	TEST FAILED VACUUM NOT ACHIEVED CONTACT TECH. SERVICE	3
E998	Remote maintenance activity in progress	REMOTE SERVICE ACTIVE	1
E999	Manually interrupting the cycle	MANUAL INTERRUPTION	3

1 = OK (warning)

2 = OK + Stopped cycle start

3 = Cycle failed + OK + RESET

17.2. ALARMS (CATEGORY A)

CODE	ALARM DESCRIPTION	MESSAGE ON THE DISPLAY	RESET MODE
A032	Problem with the level sensor of the filling tank	FILL.WATER LEVEL SENSOR PROBLEM CONTACT TECH. SERVICE	1
A040	The tank has not been filled (only with automatic filling system)	FAILED WATER INLET CHECK AUTOMATIC LOAD	1
A042	The MAX water level in the filling tank has been reached abnormally (automatic filling)	WATER FILLING MAXIMUM LEVEL CHECK TANK	1
A101	Temperature sensor PT1 broken (sterilization chamber)	CHAMBER PROBE PT1 OPEN CIRCUIT CONTACT TECH. SERVICE	2, 3
A102	Temperature sensor PT2 broken (steam generator)	GENERATOR PROBE PT2 OPEN CIRCUIT CONTACT TECH. SERVICE	2, 3
A103	Temperature sensor PT3 broken (heating element)	HEATING BAND PROBE PT3 OPEN CIRCUIT CONTACT TECH. SERVICE	2, 3
A105	Temperature sensor PT5 broken (conductivity measurement compensation)	CONDUCTIVITY SENSOR PT5 OPEN CIRCUIT CONTACT TECH. SERVICE	1
A111	Temperature sensor PT1 short-circuited (sterilization chamber)	CHAMBER PROBE PT1 SHORT-CIRCUIT CONTACT TECH. SERVICE	2, 3
A112	Temperature sensor PT2 short-circuited (steam generator)	GENERATOR PROBE PT2 SHORT-CIRCUIT CONTACT TECH. SERVICE	2, 3
A113	Temperature sensor PT3 short-circuited (heating element)	HEATING BAND PROBE PT3 SHORT-CIRCUIT CONTACT TECH. SERVICE	2, 3
A115	Temperature sensor PT5 short-circuited (conductivity measurement compensation)	CONDUCTIVITY SENSOR PT5 SHORT-CIRCUIT CONTACT TECH. SERVICE	1
A116	ADC error	PROCESS BOARD ERROR CONTACT TECH. SERVICE	2, 3
A117	Door motor overcurrent error	DOOR MOTOR OVERCURRENT	2, 3
A120	Reference heating element acquisition chain fault	PROCESS BOARD ERROR CONTACT TECH. SERVICE	2, 3
A121	Reference heating element acquisition chain fault	PROCESS BOARD ERROR CONTACT TECH. SERVICE	2, 3
A122	Reference heating element acquisition chain fault	PROCESS BOARD ERROR CONTACT TECH. SERVICE	2, 3
A126	Connection error with Wi-Fi module	Wi-Fi MODULE ERROR CONTACT TECH. SERVICE	1
A131	Solenoid valve 1 failed	SOLENOID VALVE 1 ERROR CONTACT TECH. SERVICE	2, 3
A132	Solenoid valve 2 failed	SOLENOID VALVE 2 ERROR CONTACT TECH. SERVICE	2, 3
A133	Solenoid valve 3 failed	SOLENOID VALVE 3 ERROR CONTACT TECH. SERVICE	2, 3
A134	Solenoid valve 4 failed	SOLENOID VALVE 4 ERROR CONTACT TECH. SERVICE	2, 3
A135	Solenoid valve 5 failed	SOLENOID VALVE 5 ERROR CONTACT TECH. SERVICE	2, 3
A136	Solenoid valve 6 failed	SOLENOID VALVE 6 ERROR CONTACT TECH. SERVICE	2, 3
A140	Error during Cloud firmware update	CLOUD FW UPDATE ERROR	1
A145	Faulty current draw detected	FAULTY CURRENT DRAW CONTACT TECH. SERVICE	2, 3
A146	Solenoid valves control driver fault	SOLENOID VALVE DRIVER ERROR CONTACT TECH. SERVICE	2, 3
A147	Door motor control driver fault	DOOR MOTOR DRIVER ERROR CONTACT TECH. SERVICE	2, 3
A201	Heating not executed within time-out (steam generator)	STEAM GENERATOR RESISTOR OPEN CIRCUIT CONTACT TECH. SERVICE	3
A202	Heating not executed within time-out (tube bundle heating element)	HEATING BAND OPEN CIRCUIT CONTACT TECH. SERVICE	3

CODE	ALARM DESCRIPTION	MESSAGE ON THE DISPLAY	RESET MODE
A250	1st pulse with vacuum not reached within time out	1PV TIMEOUT CHECK LOAD CHECK CHAMBER FILTER	3
A251	1st rise back up to atmospheric pressure not reached within the time-out	ATM1 UPSTROKE TIMEOUT CONTACT TECH. SERVICE	3
A252	1st pressure pulse not reached within the time-out	1PP UPSTROKE TIMEOUT CONTACT TECH. SERVICE	3
A253	2nd pulse with vacuum not reached within time out	2PV TIMEOUT CHECK LOAD CHECK CHAMBER FILTER	3
A254	2nd rise back up to atmospheric pressure not reached within the time-out	ATM2 UPSTROKE TIMEOUT CONTACT TECH. SERVICE	3
A255	2nd pressure pulse not reached within the time-out	2PP UPSTROKE TIMEOUT CONTACT TECH. SERVICE	3
A256	3rd pulse with vacuum not reached within time out	3PV TIMEOUT CHECK LOAD CHECK CHAMBER FILTER	3
A257	3rd rise back up to atmospheric pressure not reached within the time-out	ATM3 UPSTROKE TIMEOUT CONTACT TECH. SERVICE	3
A258	3rd pressure pulse not reached within the time out	3PP UPSTROKE TIMEOUT CONTACT TECH. SERVICE	3
A260	Chamber depressurization not reached within time out	ATM3 DOWNSTROKE TIMEOUT CHECK LOAD CHECK CHAMBER FILTER	3
A261	Chamber levelling not reached within time out	PRESSURE LEVELLING TIMEOUT CONTACT TECH. SERVICE	3
A262	Vacuum pulsation during drying not executed within time-out	PD PRESSURE UPSTROKE TIMEOUT CONTACT TECH. SERVICE	3
A353	1st drop to atmospheric pressure not completed within the time-out	ATM1 DOWNSTROKE TIMEOUT CHECK LOAD CHECK CHAMBER FILTER	3
A356	2nd drop to atmospheric pressure not completed within the time-out	ATM2 DOWNSTROKE TIMEOUT CHECK LOAD CHECK CHAMBER FILTER	3
A360	Vacuum pulsation after maintenance step not executed within time-out	SPD PRESSURE DOWNSTROKE TIMEOUT CONTACT TECH. SERVICE	3
A362	Chamber depressurisation during drying not reached within time-out	PD PRESSURE DOWNSTROKE TIMEOUT CONTACT TECH. SERVICE	3

1 = OK (warning)

2 = OK + Stopped cycle start

3 = Cycle failed + OK + RESET

17.3. HAZARDS (CATEGORY H)

CODE	ALARM DESCRIPTION	MESSAGE ON THE DISPLAY	RESET MODE
H150	MPX pressure sensor broken/not connected	PRESSURE SENSOR OPEN CIRCUIT CONTACT TECH.SERVICE	2, 3
H160	MPX pressure sensor short-circuited	PRESSURE SENSOR SHORT-CIRCUIT CONTACT TECH.SERVICE	2, 3
H400	Pconv/T ratio not balanced (Pconv>T) (STERILIZATION phase)	INCORRECT P/T RATIO CHECK LOAD	3
H401	T/Pconv ratio not balanced (T>Pconv) (STERILIZATION phase)	INCORRECT T/P RATIO CHECK LOAD	3
H402	Temperature over the MAX limit (STERILIZATION phase)	TEMPERATURE BEYOND MAXIMUM LIMIT CONTACT TECH. SERVICE	3
H403	Temperature below the MIN limit (STERILIZATION phase)	TEMPERATURE BELOW MINIMUM LIMIT CONTACT TECH. SERVICE	3
H404	Floating temperature over the limit (STERILIZATION phase)	ERRATIC TEMPERATURE CONTACT TECH. SERVICE	3
H405	Pressure over the MAX limit (STERILIZATION phase)	PRESSURE BEYOND MAXIMUM LIMIT CONTACT TECH. SERVICE	3
H406	Pressure below MIN limit (STERILIZATION phase)	PRESSURE BELOW MINIMUM LIMIT CONTACT TECH. SERVICE	3
H410	Time measurement error	INTERNAL TIMER ERROR CONTACT TECH. SERVICE	2, 3
H411	Sterilization time error	STERILIZATION TIME ERROR	3
H990	Excessive pressure (sterilization chamber, MPX)	PRESSURE BEYOND MAXIMUM LIMIT CONTACT TECH. SERVICE	2, 3
H991	Overheating (sterilization chamber, PT1)	PT1 OVERHEATING CHECK LOAD	2, 3
H992	Overheating (steam generator, PT2)	PT2 OVERHEATING CONTACT TECH. SERVICE	2, 3
H993	Overheating (layer resistance, PT3)	PT3 OVERHEATING CONTACT TECH. SERVICE	2, 3

1 = OK (warning)

2 = OK + Stopped cycle start

3 = Cycle failed + OK + RESET

17.4. SYSTEM ERRORS (CATEGORY S)

CODE	ALARM DESCRIPTION	MESSAGE ON THE DISPLAY	RESET MODE
S001	Flash memory 1 on process board failed	FLASH MEMORY NOT ACCESSIBLE CONTACT TECH. SERVICE	2, 3
S002	Flash memory 2 on process board failed	FLASH MEMORY NOT ACCESSIBLE CONTACT TECH. SERVICE	2, 3
S005	USB stick not accessible	PROBLEM WITH USB KEY CHANGE KEY	1
S006	USB stick not accessible	USB KEY NOT ACCESSIBLE CHANGE KEY	1
S007	USB stick full	USB KEY FULL CHANGE KEY	1
S009	Printer not connected	PRINTER DISCONNECTED CHECK CONNECTION	1
S010	Printer: there is no paper or there might be a configuration error	PRINTER PAPER OUT CHECK PAPER	1
S011	Printer cover open	PRINTER: DOOR OPEN	1
S012	Probable printer configuration error	PRINTER: NOT READY TRY AGAIN	1
S020	Cycle backup not done	RUN BACKUP DOWNLOAD NEW CYCLES	1
S021	Cycle storage limit exceeded	CYCLE MEMORY FULL START OVERWRITING	1
S030	Check, using a watchdog, that one of main tasks is not in crash condition	SYSTEM ERROR CONTACT TECH.SERVICE	2, 3
S031	Check, using a hardware watchdog, that one peripheral is not in lock condition.	SYSTEM ERROR CONTACT TECH.SERVICE	2, 3
S032	Check, using a watchdog, that one of main tasks is not in lock condition (e.g. infinite loop)	SYSTEM ERROR CONTACT TECH.SERVICE	2, 3
S034	SW malfunction	SYSTEM ERROR CONTACT TECH.SERVICE	2, 3
S035	SW malfunction in solenoid valve management	SYSTEM ERROR CONTACT TECH.SERVICE	2, 3
S040	Check the log saving in the Flash memory	SYSTEM ERROR CONTACT TECH.SERVICE	2, 3
S041	Cycle performed with 4-minute sterilization time at 134°C	LOG SAVE ERROR CONTACT TECH. SERVICE	1
S042	Cycle performed with standard drying	4-MINUTE STERILIZATION COMPLETED	1
S099	Error during cycle report creation	STANDARD DRYING CHECK LOAD DRYING	1
S100	SW malfunction	PROBLEM IN CREATING CYCLE REPORT CONTACT TECH. SERVICE	2, 3

1 = OK (warning)

2 = OK + Stopped cycle start

3 = Cycle failed + OK + RESET

17.5. TROUBLESHOOTING



According to the **type of alarm** occurred, please find below the indications to detect the possible causes and restore the proper operation:

17.5.1. ERRORS (CATEGORY E)



The alarm codes in the list can refer to functions that are not present on the models concerned in this Manual.

CODE	POSSIBLE CAUSE	SUGGESTED SOLUTION
E000	Sudden power failure (blackout).	Wait for the power to be restored and do a RESET following the instructions.
	The main switch has accidentally been turned off and/or the power plug pulled from the socket.	Reconnect the plug and/or turn the device on again and RESET according to the instructions.

CODE	POSSIBLE CAUSE	SUGGESTED SOLUTION
	Network fuses blown.	Replace with good fuses of equal nominal value. (See the Summary Table in Appendix Technical Characteristics). Turn the device on again and RESET according to the instructions.
E001	Abnormal voltage peak on the mains.	Reset according to the instructions. If the problem occurs again, have the mains electric system checked by a technician.
E002	The filling tank contains water of inadequate quality.	RESET according to the instructions. Empty the filling tank and refill it with distilled water of adequate quality (<15µs/cm).
E003	The filling tank contains water of very poor quality.	RESET according to the instructions. IMMEDIATELY empty the filling tank and refill it with distilled water of adequate quality (<15µs/cm).  <i>In these conditions, the sterilizer allows starting a maximum of 5 cycles, after which it locks until the tank is filled with distilled water of adequate quality (<15 µs/cm). This precaution is necessary to prevent damage to the device.</i>
E004	Failure to main board.	RESET according to the instructions. Contact Technical Service (see Appendix).
	Disturbance on the electrical mains.	RESET according to the instructions. If the problem occurs again, have the electrical mains checked by a technician. If the electrical mains is equipped with a Continuity system, have the system checked by a technician.
E007	One or more rear fans failed	RESET according to the instructions. Check the operation of rear fans and contact Technical Service (see Appendix).
E008	The filling/discharge tank contains water of inadequate quality.	RESET according to the instructions. If no integrated filters are equipped, empty the filling tank and refill it with distilled water of adequate quality (<15 µs/cm). If an automatic filling system is present, empty the external container and fill it with water of adequate quality. If a Pure100/500 demineraliser or integrated filters are present, replace the filter elements.
E009	The filling/discharge tank contains water of very poor quality.	RESET according to the instructions. If no integrated filters are equipped, empty the filling tank IMMEDIATELY and refill it with distilled water of adequate quality (<15 µs/cm). If an automatic filling system is present, IMMEDIATELY empty the external container and fill it with water of adequate quality. If a Pure100/500 demineraliser or integrated filters are present, replace the filter elements IMMEDIATELY.  <i>In these conditions, the sterilizer allows starting a maximum of 5 consecutive cycles, after which it locks until the tank is filled with distilled water of adequate quality (<15 µs/cm) or integrated filters (if any) are replaced. This precaution is necessary to prevent damage to the device.</i>
E010	Door open (or not properly closed) at program start (START).	RESET according to the instructions. Properly close the door and restart the program.
	Door position microswitch failure.	Contact Technical Service (see Appendix).
E011	The discharge tank contains water of very poor quality.	RESET according to the instructions. Empty both tanks IMMEDIATELY, replace filter elements and fill the filling tank.
E012	The cycle limit after which integrated filters must be replaced has been reached.	RESET according to the instructions. Empty both tanks IMMEDIATELY, replace filter elements and fill the filling tank.
E013	The filling tank contains water of very poor quality.	RESET according to the instructions. Empty the filling tank IMMEDIATELY and replace the demineralisation filter.  <i>In these conditions, the sterilizer allows starting a maximum of 5 consecutive cycles, after which cycles are automatically aborted until the correct water quality is detected (<15 µs/cm). This precaution is necessary to prevent damage to the device.</i>

CODE	POSSIBLE CAUSE	SUGGESTED SOLUTION
E020	Door lock mechanism limit microswitch failure.	RESET according to the instructions. Try restarting the program a second time. If the problem persists, contact Technical Service (see the Appendix).
	Door lock system gearmotor failure.	
E021	Door lock mechanism limit microswitch failure.	RESET according to the instructions. Contact Technical Service (see Appendix).
	Door lock system gearmotor failure.	
E022	Door lock microswitches failure	RESET according to the instructions. Contact Technical Service (see Appendix).
E030	Water level in the filling tank below minimum.	RESET according to the instructions. Top up with water up to the MAX level (or at least up to over the MIN level).
	MIN water level sensor failure.	Contact Technical Service (see Appendix).
E031	Water level in the drain tank over the MAX level.	RESET according to the instructions and empty the tank. Completely drain the drain tank.
	MAX water level sensor failure.	Contact Technical Service (see Appendix).
	Problem in the hydraulic circuit.	
E042	Warning that the maximum water level in the tank has been reached (manual filling)	Interrupt the filling operation to prevent water spillage.
E050	Reminder to run Vacuum Test cycle	Run Vacuum Test as planned
E051	Reminder to run Helix Test cycle	Run Helix Test cycle as planned
E052	Reminder to run Vacuum + Helix Test combined cycle	Run Vacuum + Helix Test combined cycle as planned
E060	The autoclave cannot connect to Lan network	Make sure that configuration parameters of the Lan network are correct. Check that the Lan network chosen for the connection is working properly. Contact Technical Service (see Appendix).
E061	The autoclave cannot connect to Wi-Fi network	Make sure that configuration parameters of the Wi-Fi network are correct. Check that the router managing the Wi-Fi network is on and that the Wi-Fi network chosen for the connection is working properly. Contact Technical Service (see Appendix).
E070	Preheating activation with door open. The message is displayed after 10 minutes and after 20 minutes.	Always close the door when the sterilizer is not in cycle
E126	Cloud firmware update in progress	Wait that the message disappears then turn the sterilizer off and back on.
E130	The cycle you want to start is not enabled	Contact Technical Service (see Appendix).
E141	Cloud firmware version is not the correct one compared to Process firmware version. Malfunctions may occur during connection with Wi-Fi, Ethernet or Cloud	Update Cloud firmware or Process firmware to align the two firmwares to the correct version. Contact Technical Service (see Appendix).
E900	Air seepage through the gasket.	RESET according to the instructions. Thoroughly clean the gasket with a clean cotton cloth moistened with water. Restart the program.
	Problem in the hydraulic circuit.	Contact Technical Service (see Appendix).
E901	Excessive humidity in the sterilization chamber.	RESET according to the instructions. Thoroughly dry the inside of the chamber and restart the program.

CODE	POSSIBLE CAUSE	SUGGESTED SOLUTION
	Air seepage through the gasket.	RESET according to the instructions. Thoroughly clean the gasket with a clean cotton cloth moistened with water. Restart the program.
	Problem in the hydraulic circuit.	Contact Technical Service (see Appendix).
E902	Excessive humidity in the sterilization chamber.	RESET according to the instructions. Thoroughly dry the inside of the chamber and restart the program.
	Air seepage through the gasket.	RESET according to the instructions. Thoroughly clean the gasket with a clean cotton cloth moistened with water. Restart the program.
	Vacuum pump failure. Problem in the hydraulic circuit.	Contact Technical Service (see Appendix).
E998	Service maintenance in progress.	Service maintenance in progress. If you were not informed, contact IMMEDIATELY the manager of the network to which the sterilizer is connected. Contact Technical Service (see Appendix).
E999	Manual interruption of the sterilization or test cycle.	RESET according to the instructions.

17.5.2. ALARMS (CATEGORY A)

CODE	POSSIBLE CAUSE	SUGGESTED SOLUTION
A032	Connector of water level sensors in the filling tank not connected.	Contact Technical Service (see Appendix).
	Failure of water level sensor(s) in the filling tank.	
A040	Lack of water in the external container (automatic filling)	RESET according to the instructions. Fill the container with a sufficient quantity of water (check the level at regular intervals).
	Automatic filling system not properly installed.	RESET according to the instructions. Check that the filling tube is properly connected. Remove any obstruction along the tube path.
	Automatic filling system failure.	Contact Technical Service (see Appendix).
A042	Possible problem to the Automatic filling system	Contact Technical Service (see Appendix).
A101	Chamber temperature sensor failure (PT1).	Contact Technical Service (see Appendix).
A102	Steam generator temperature sensor failure (PT2).	
A103	Heating element temperature sensor failure (PT3).	
A105	Temperature sensor PT5 failed (conductivity measurement compensation)	
A111	Incorrect temperature sensor connection (sterilization chamber).	
	Temperature sensor short-circuit (sterilization chamber).	
A112	Incorrect temperature sensor connection (steam generator).	
	Temperature sensor short-circuit (steam generator).	
A113	Incorrect temperature sensor connection (heating element).	
	Temperature sensor short-circuit (heating element).	
A115	Temperature sensor PT5 short-circuited (conductivity measurement compensation).	
A116	ADC error.	
A117	Lack of lubrication in the door lock system	Lubricate the door lock system.
A120	Reference heating element acquisition chain fault.	Contact Technical Service (see Appendix).
A121	Reference heating element acquisition chain fault.	
A122	Reference heating element acquisition chain fault.	
A126	Connection error with Wi-Fi module	Contact Technical Service (see Appendix).
A131	Solenoid valve 1 failed	
A132	Solenoid valve 2 failed	
A133	Solenoid valve 3 failed	
A134	Solenoid valve 4 failed	
A135	Solenoid valve 5 failed	
A136	Solenoid valve 6 failed	
A140	Error during Cloud firmware update	Check mains voltage. Contact Technical Service (see Appendix).
A145	Faulty current draw detected	
A146	Solenoid valves control driver fault	Contact Technical Service (see Appendix).
A147	Door motor control driver fault	
A201	Steam generator safety thermostat triggered.	
	Steam generator or heating element malfunction.	
A202	Heating band safety thermostat triggered.	
	Heating band malfunction.	
A250	Water or condensate in the sterilization chamber.	RESET according to the instructions. Thoroughly dry the inside of the sterilization chamber and restart the cycle. Do <u>not</u> insert material impregnated with water or in general with liquids into the chamber.
	Drain filter obstructed.	Clean the drain filter. (See Appendix Maintenance).
	Air seepage through the gasket.	RESET according to the instructions. Thoroughly clean the gasket with a clean cotton cloth moistened with water. Restart the cycle.
	Vacuum pump failure.	Contact Technical Service (see Appendix).
	Problem in the hydraulic circuit.	
A251	Water injection pump malfunction.	Contact Technical Service (see Appendix).
	Problem in the hydraulic circuit.	
	Steam generator safety thermostat triggered.	
	Steam generator malfunction.	

CODE	POSSIBLE CAUSE	SUGGESTED SOLUTION
A252	Steam seepage through the gasket.	RESET according to the instructions. Thoroughly clean the gasket with a clean cotton cloth moistened with water. Restart the cycle.
	Excessive load.	RESET according to the instructions. Check that the load does not exceed the maximum values permitted. (See the <u>Summary Table in Appendix, Technical Characteristics</u>).
	Problem in the hydraulic circuit.	Contact Technical Service (see <u>Appendix</u>).
	Steam generator safety thermostat triggered.	
	Steam generator malfunction.	
A253	Water or condensate in the sterilization chamber.	RESET according to the instructions. Thoroughly dry the inside of the sterilization chamber and restart the program. Do <u>not</u> insert material impregnated with water or in general with liquids into the chamber.
	Air seepage through the gasket.	RESET according to the instructions. Thoroughly clean the gasket with a clean cotton cloth moistened with water. Restart the program.
	Vacuum pump failure.	Contact Technical Service (see <u>Appendix</u>).
	Problem in the hydraulic circuit.	
A254	Water injection pump malfunction.	Contact Technical Service (see <u>Appendix</u>).
	Problem in the hydraulic circuit.	
	Steam generator safety thermostat triggered.	
	Steam generator malfunction.	
A255	Steam seepage through the gasket.	RESET according to the instructions. Thoroughly clean the gasket with a clean cotton cloth moistened with water. Restart the program.
	Excessive load.	RESET according to the instructions. Check that the load does not exceed the maximum values permitted. (See the <u>Summary Table in Appendix, Technical Characteristics</u>).
	Problem in the hydraulic circuit.	Contact Technical Service (see <u>Appendix</u>).
	Steam generator safety thermostat triggered.	
	Steam generator malfunction.	
A256	Water or condensate in the sterilization chamber.	RESET according to the instructions. Thoroughly dry the inside of the sterilization chamber and restart the program. Do <u>not</u> insert material impregnated with water or in general with liquids into the chamber.
	Air seepage through the gasket.	RESET according to the instructions. Thoroughly clean the gasket with a clean cotton cloth moistened with water. Restart the program.
	Vacuum pump failure.	Contact Technical Service (see <u>Appendix</u>).
	Problem in the hydraulic circuit.	
A257	Water injection pump malfunction.	Contact Technical Service (see <u>Appendix</u>).
	Problem in the hydraulic circuit.	
	Steam generator safety thermostat triggered.	
	Steam generator malfunction.	
A258	Steam seepage through the gasket.	RESET according to the instructions. Thoroughly clean the gasket with a clean cotton cloth moistened with water and restart the program.
	Excessive load.	RESET according to the instructions. Check that the load does not exceed the maximum values permitted. (See the <u>Summary Table in Appendix, Technical Characteristics</u>).
	Problem in the hydraulic circuit.	Contact Technical Service (see <u>Appendix</u>).
	Steam generator safety thermostat triggered.	
	Steam generator malfunction.	
A260	Drain filter obstructed.	Clean the drain filter (see <u>Appendix Maintenance</u>).
	Problem in the hydraulic circuit.	Contact Technical Service (see <u>Appendix</u>).
A261	Bacteriological filter obstructed.	Clean the drain filter (see <u>Appendix Maintenance</u>).
	Problem in the hydraulic circuit.	Contact Technical Service (see <u>Appendix</u>).
A262	Bacteriological filter obstructed.	Clean the drain filter (see <u>Appendix Maintenance</u>).
	Problem in the hydraulic circuit.	Contact Technical Service (see <u>Appendix</u>).
A353	Drain filter obstructed.	Clean the drain filter (see <u>Appendix Maintenance</u>).
	Problem in the hydraulic circuit.	Contact Technical Service (see <u>Appendix</u>).
A356	Drain filter obstructed.	Clean the drain filter (see <u>Appendix Maintenance</u>).
	Problem in the hydraulic circuit.	Contact Technical Service (see <u>Appendix</u>).
A360	Drain filter obstructed.	Clean the drain filter (see <u>Appendix Maintenance</u>).

CODE	POSSIBLE CAUSE	SUGGESTED SOLUTION
	Problem in the hydraulic circuit.	Contact Technical Service (see Appendix).
A362	Drain filter obstructed.	Clean the drain filter (see Appendix Maintenance).
	Problem in the hydraulic circuit.	Contact Technical Service (see Appendix).

17.5.3. HAZARDS (CATEGORY H)

CODE	POSSIBLE CAUSE	SUGGESTED SOLUTION																
H150	Pressure sensor failure (MPX).	Contact Technical Service (see Appendix).																
H160	Pressure sensor (MPX) not properly connected to the connector.																	
	Pressure sensor short-circuit (MPX).																	
H400	Problem in the hydraulic circuit.																	
H401	Problem in the hydraulic circuit.																	
H402	Steam generator malfunction.																	
	Problem in the hydraulic circuit.																	
H403	Steam generator malfunction.																	
	Problem in the hydraulic circuit.																	
H404	Problem in the hydraulic circuit.																	
	Steam generator malfunction.																	
H405	Problem in the hydraulic circuit.																	
	Steam generator malfunction.																	
H406	Problem in the hydraulic circuit.																	
	Steam generator malfunction.																	
H410	Timer problem.																	
H411	Sterilization time error.																	
H990	General operating problem.																	
H991	General operating problem.																	
H992	General operating problem.																	
H993	General operating problem.																	

17.5.4. SYSTEM ERRORS (CATEGORY S)

CODE	POSSIBLE CAUSE	SUGGESTED SOLUTION
S001	Error of Flash memory 1 on process board Flash memory 1 on process board failed	Contact Technical Service (see Appendix).
S002	Error of Flash memory 2 on process board Flash memory 2 on process board failed	Contact Technical Service (see Appendix).
S005	USB stick not correctly formatted Damaged USB stick	Check USB key correct formatting (FAT32). As an alternative, use another correctly formatted USB key. If the problem persists, contact Technical Service (see Appendix).
S006	USB stick not correctly formatted Damaged USB stick	Check USB key correct formatting (FAT32). As an alternative, use another correctly formatted USB key. If the problem persists, contact Technical Service (see Appendix).
S007	USB stick full	Download data from USB stick or use another USB stick. If the problem persists, contact Technical Service (see Appendix).
S009	Printer off. Data cable not correctly connected to serial ports RS-232.	Make sure that printer is on. Check printer cable correct connection. If the problem persists, contact Technical Service (see Appendix).
S010	No paper inside printer. Paper setting configuration not correctly done.	Make sure that paper is correctly loaded. Check printer cable correct connection. Make sure that paper settings are correct. If the problem persists, contact Technical Service (see Appendix).
S011	Printer lid open	Make sure that printer lid is correctly closed. Check printer cable correct connection. If the problem persists, contact Technical Service (see Appendix).
S012	Printer not ready for use	Make sure that paper is correctly loaded. Check printer cable correct connection. Make sure that paper settings are correct. If the problem persists, contact Technical Service (see Appendix).
S020	Cycle back-up not done after 250 cycles	Perform cycle back-up. See paragraph Sterilization cycle back-up. If the problem persists, contact Technical Service (see Appendix).
S021	Cycle storage limit exceeded after 7000 cycles	Perform cycle back-up. See paragraph Sterilization cycle back-up. If the problem persists, contact Technical Service (see Appendix).
S030	Malfunction of the control software	RESET according to the instructions. Try restarting the program a second time. If the problem persists, contact Technical Service (see Appendix).
S031	Malfunction of control board or software	RESET according to the instructions. Try restarting the program a second time. If the problem persists, contact Technical Service (see Appendix).
S032	Malfunction of the control software	RESET according to the instructions. Try restarting the program a second time. If the problem persists, contact Technical Service (see Appendix).
S034	Malfunction of the control software	RESET according to the instructions. Try restarting the program a second time. If the problem persists, contact Technical Service (see Appendix).
S035	Control software malfunction in solenoid valve management	RESET according to the instructions. Try restarting the program a second time. If the problem persists, contact Technical Service (see Appendix).
S040	Malfunction of the control software	RESET according to the instructions. Try restarting the program a second time. If the problem persists, contact Technical Service (see Appendix).
S041	Malfunction of control board or control software	Contact Technical Service (see Appendix).
S042	Malfunction of control board or software	Contact Technical Service (see Appendix).
S099	Malfunction of control board or software	Try restarting the program a second time. Try replacing the USB key. If the problem persists, contact Technical Service (see Appendix).
S100	Malfunction of control board or software	Contact Technical Service (see Appendix).

18. USER PIN RESET

 If the user enters the pin incorrectly for 3 times, it is necessary to enter the following unlock pin for four consecutive times when you will be prompted to enter pin again:

9999

19. APPENDIX - ACCESSORIES

Only use spare parts and accessories that meet the manufacturer's specifications.

DEMINERALIZER PURE100

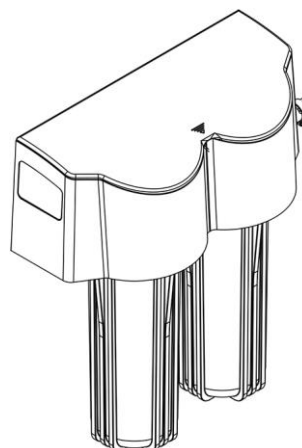

DEMINERALIZER PURE500
TWIN PURE 500

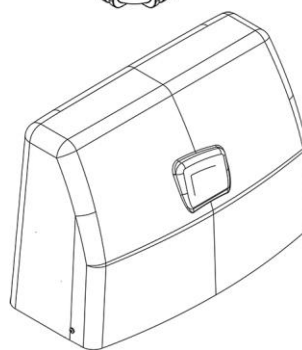

The above mentioned accessories are not available for S versions.

AUTOMATIC FILLING

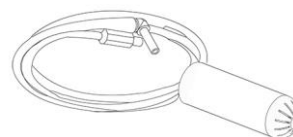

FRONT FILLING

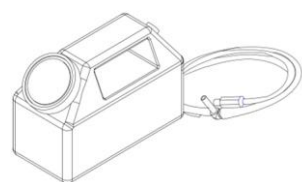

H₂O AUXILIARY SOLENOID VALVE

Additional SV kit including:

- 1 2-way water solenoid valve, NC - 24 V DC
- 2 Steel support and fastening screws
- 3 Connection cable with plug
- 4 Silicone hose with connector
- 5 Control valve
- 6 1-way valve

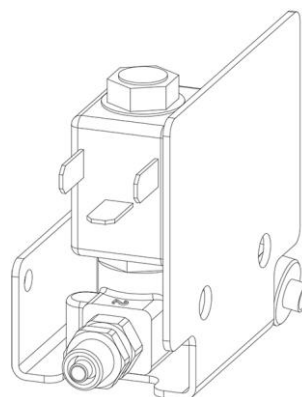

For the management of automatic filling accessories, refer to the manual of the relevant accessory.

EXTERNAL PRINTER

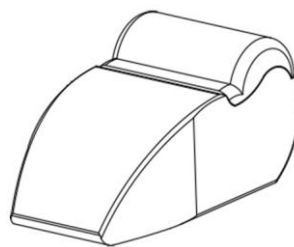

BARCODE READER

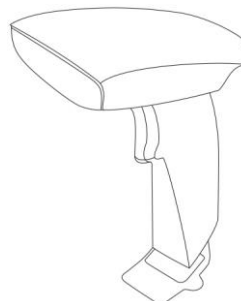

DATA STER SOFTWARE

MY TRACE SOFTWARE

20. PRINTER CONNECTION

Connect the printer to the RS232 serial port located on the rear of the autoclave (see figure).

Load the desired type of paper and turn on the printer.
Set the type of paper loaded (see the paragraph PRINT MANAGEMENT).

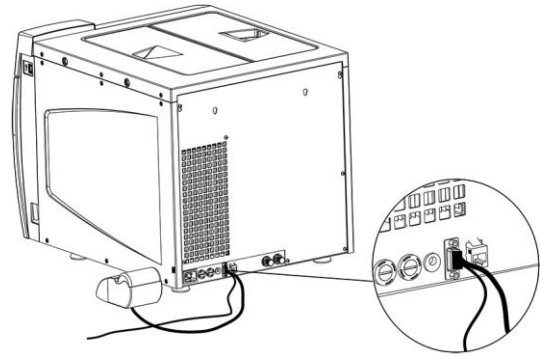

 Refer to the printer manual for printer starting and paper loading.

21. APPENDIX - SPARE PARTS AND ACCESSORIES

 Only use spare parts and accessories that meet the manufacturer's specifications.

Description	Code
bacteriological filter	97290160
door gasket (17/22 l)	97400145
door gasket (28 l only)	97467176
demineralised water tank/chamber filter	97290210

22. APPENDIX - TECHNICAL SERVICE

FOR ANY REQUEST FOR TECHNICAL INTERVENTION ON THE PRODUCT,
BOTH UNDER WARRANTY AND OUT OF WARRANTY, DIRECTLY CONTACT
THE DEALER OR RESELLER THAT SUPPLIED IT.

We will gladly provide any information you may need on the product as well as give you suggestions and advice on the water steam sterilization procedures.

In this regard, please refer to the following address:

Cefla S.c.

Plant

Via Bicocca, 14/C

40026 - Imola (BO) IT

Tel. +39 0542 653441 Fax. +39 0542 653555

Headquarters

Via Selice Provinciale 23/A – 40026 Imola (BO) IT

23. APPENDIX - WARNINGS AND LOCAL REGULATIONS

Please consult the Web site of the manufacturer to find a list of authorised representatives.



Before carrying out any technical service operations, consult the service manual containing the above instructions.



www.cefla.com